

Parents/ Guardians,

In this folder is your child's NTI (Non-

traditional instruction) work for days 1-10 if we have to miss school due to inclement weather, sickness, etc. Please keep it in a safe place as we may need to use it for at home learning. Attendance is taken on

these days and participation is required. We will be asking for work to be turned in upon returning to school. A One Call will be sent out if the district decides to call any NTI days. If you have any further questions, please send me an email or message on

class Dojo.

Thanks so much,

Addison Mckinney

addison.mckinney@fulton.kyschools.us

# Nursery Rhymes

Nursery rhymes are a proven way to increase children's reading ability. Here are some traditional rhymes you can say with your child. Find more nursery rhymes at [www.prekinders.com/nursery-rhymes/](http://www.prekinders.com/nursery-rhymes/)

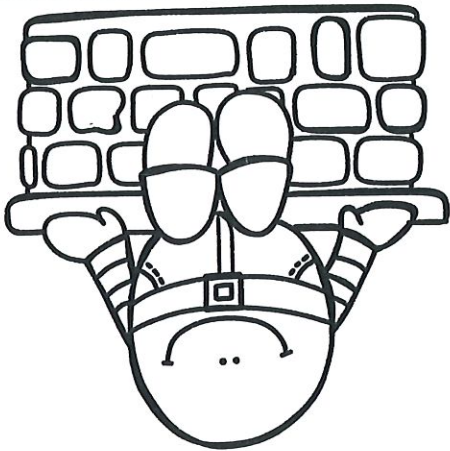

Humpty Dumpty sat on a wall,  
Humpty Dumpty had a great fall.  
All the king's horses  
And all the king's men  
Couldn't put Humpty together again.

Hey diddle diddle,  
The cat and the fiddle,  
The cow jumped over the moon.  
The little dog laughed,  
To see such sport  
And the dish ran away with the spoon.

Little boy blue  
Come blow your horn.  
The sheep's in the meadow,  
The cow's in the corn.  
Where is the boy  
Who looks after the sheep?  
He's under the haystack fast asleep.

Here is the beehive.  
Where are the bees?  
Hidden away where nobody sees.  
Watch and you'll see them  
Come out of the hive:  
1 ... 2 ... 3 ... 4 ... 5 ... BUZZ!

Hickory dickory dock,  
The mouse ran up the clock.  
The clock struck one,  
The mouse ran down,  
Hickory dickory dock.

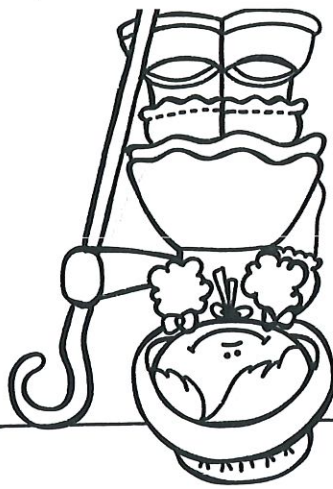

Little Bo Peep has lost her sheep,  
And doesn't know where to find them.  
Leave them alone and they'll come home,  
Wagging their tails behind them.

**DAY 1**  
**of NTI**  
**Work**

Name: \_\_\_\_\_

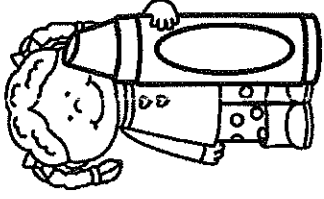

# Alphabet Tracing

B	I	Z	T	N
A	O	N	S	Y
L	L	R	X	
E	K	O	W	
D	T	P	V	
C	H	O	U	

Name: \_\_\_\_\_

# Alphabet Tracing

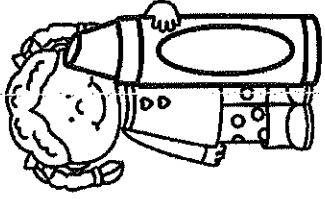

o	u	c	t	n
d	o	e	s	y
f	l	r	x	
e	k	g	m	
b	j	q	v	
c	i	o	u	

Name: -----

# Number Tracing

1	2	3	4	5	6	7	8	9
---	---	---	---	---	---	---	---	---

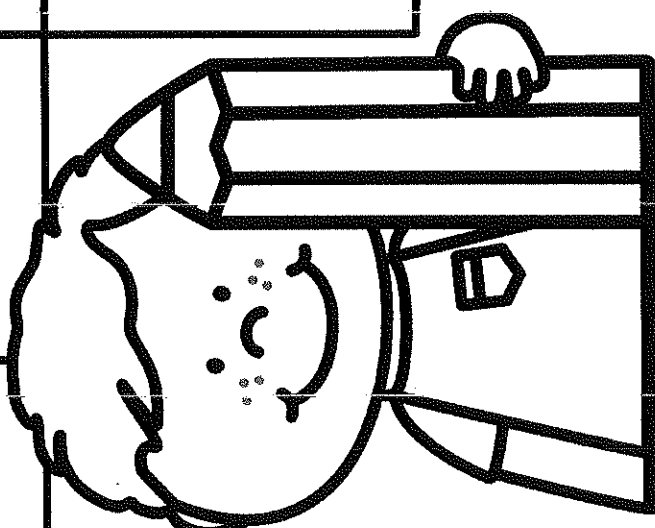

A cartoon illustration of a young girl with a large pencil. She has a round face with a smiling mouth and a few freckles. She is wearing a collared shirt and a jacket. She is holding a very large pencil vertically, with her right hand near the eraser and her left hand near the tip. The pencil is as tall as she is.

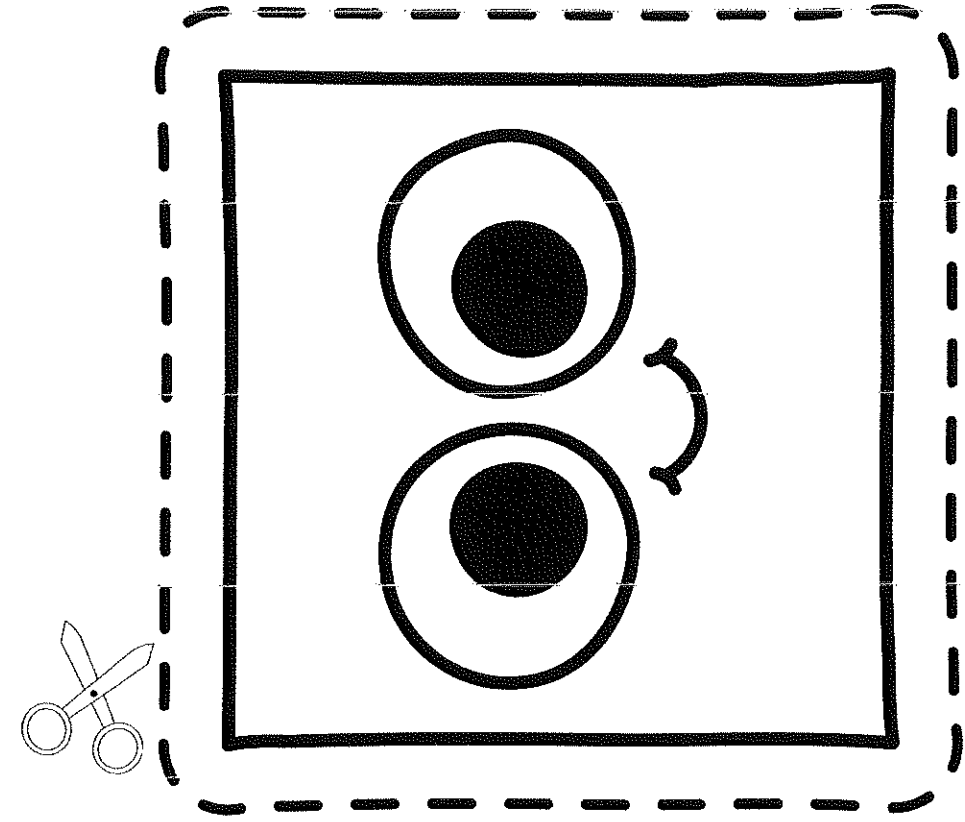

Cut. Color black.

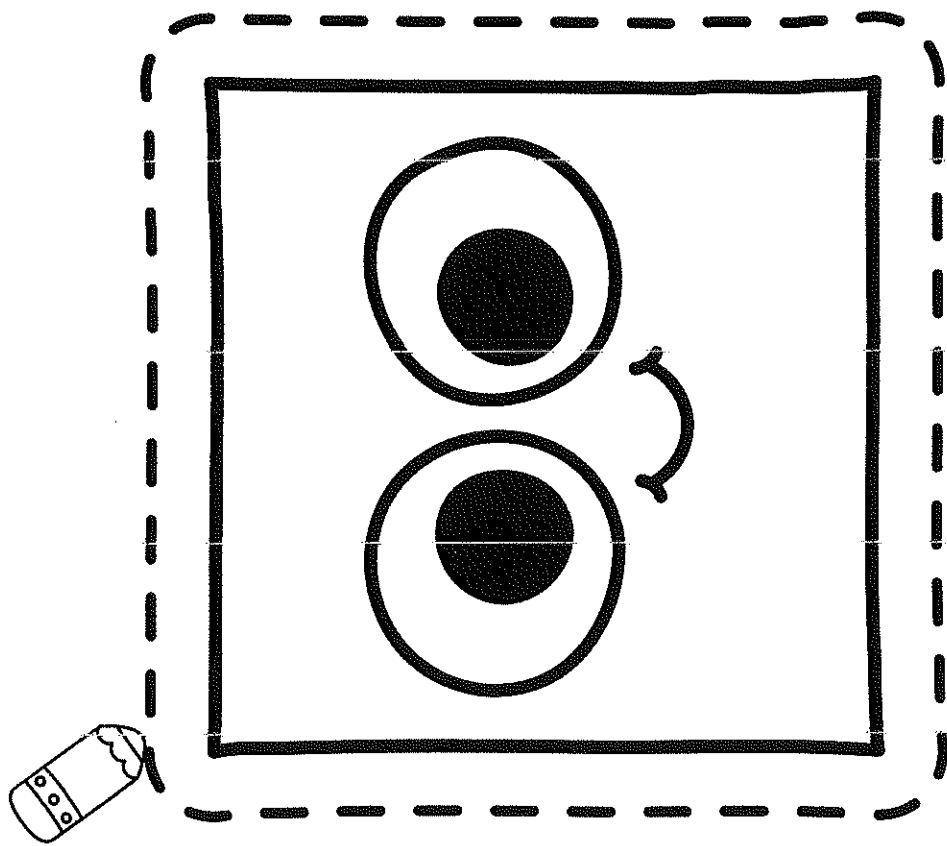

Trace. Color orange.

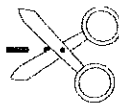

Name: \_\_\_\_\_

Find and circle A

Color the items that start with A

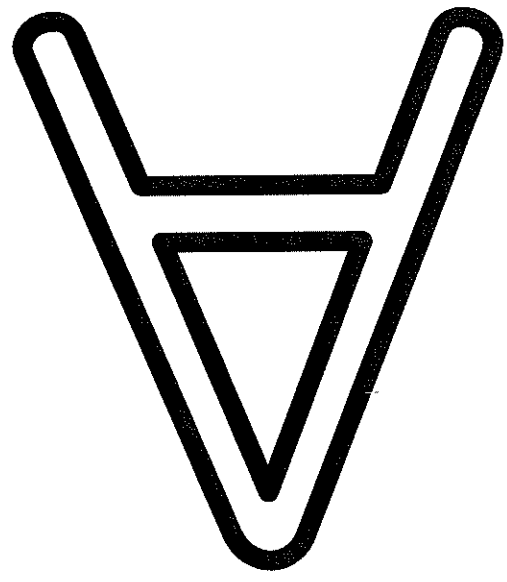
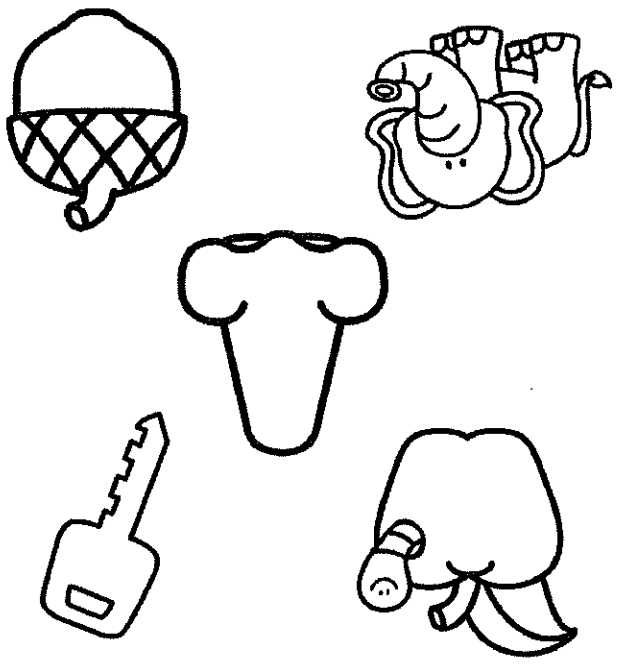

Color the letter

Trace and write



**DAY 2**  
**of NTI**  
**Work**

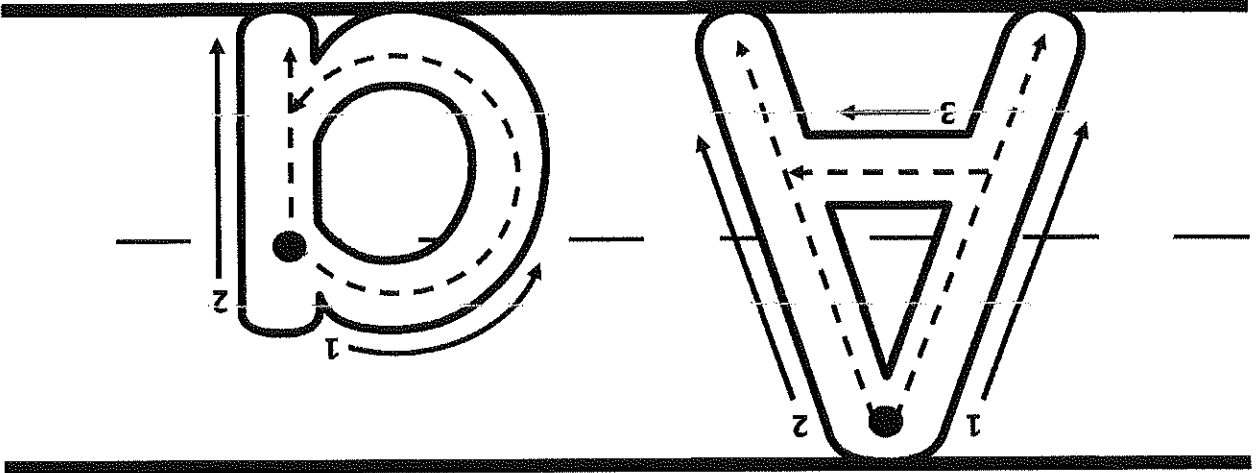

Trace the letter A.

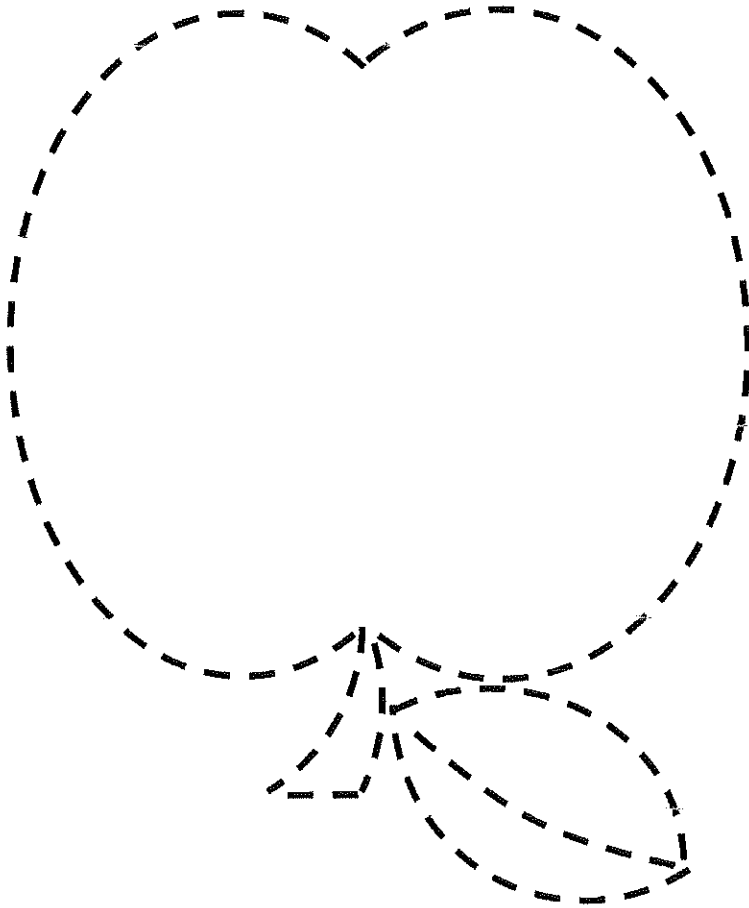

Trace the apple.

Trace and Print

Name: \_\_\_\_\_

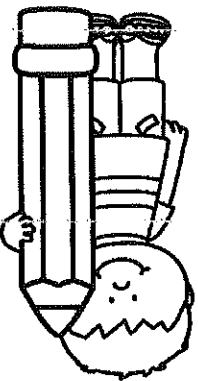

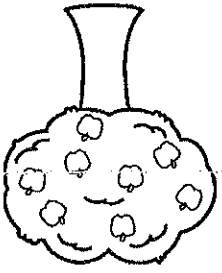

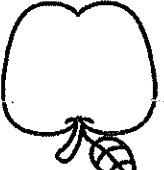
A	P	A	Z	E	A	I
A	H	O	R	A	U	K
X	A	C	Q	A	V	O
A	N	F	A	R	D	A
J	A	B	M	A	L	Y
A	E	P	H	R	A	

Go through the maze by dabbing the letter A from the apple to the tree.

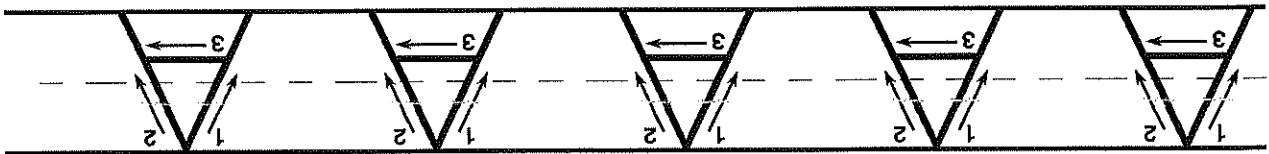

Trace the letter A.

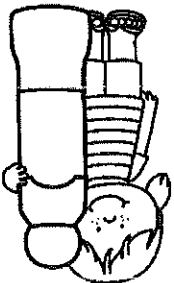

# Letter A Maze

Name: -----



Directions: Practice printing the number and the number word.

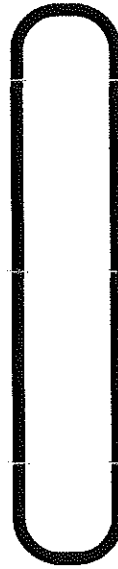
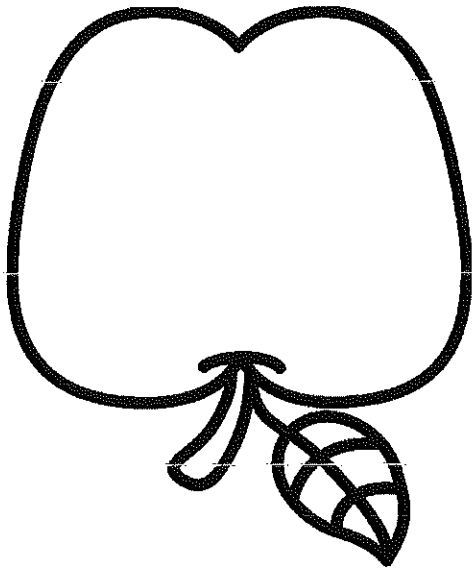

Directions: Color the picture and the number 1

Color and Trace  
Number 1

Name: \_\_\_\_\_

pepper

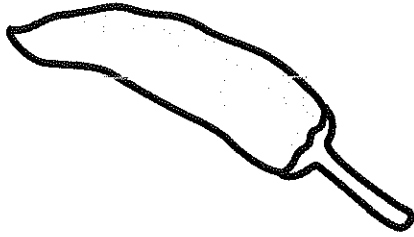

apple

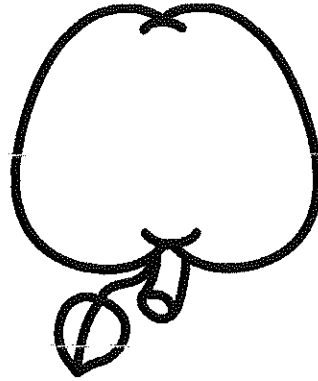

heart

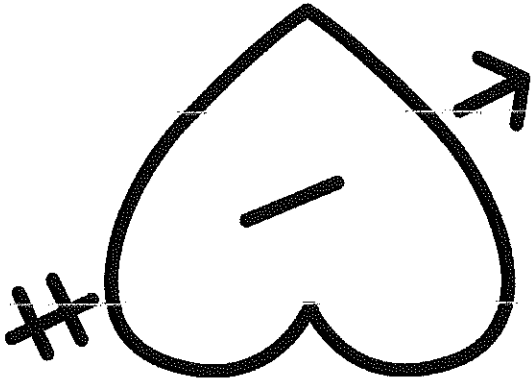

cherry

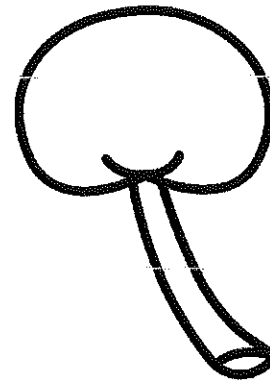

fire truck

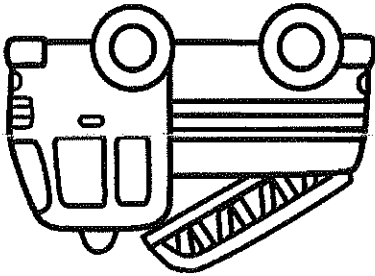

strawberry

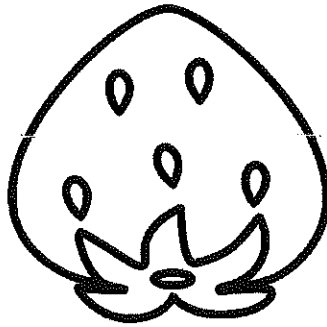

crab

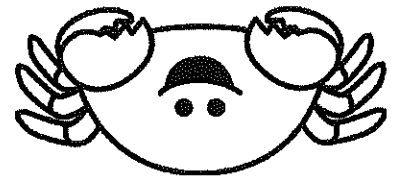

Color the pictures

red

Trace and write the word

Red

Name: \_\_\_\_\_

Name: \_\_\_\_\_

# Apple Size Ordering

Directions: Cut out the pictures and glue them in the boxes from smallest to largest.

--	--	--

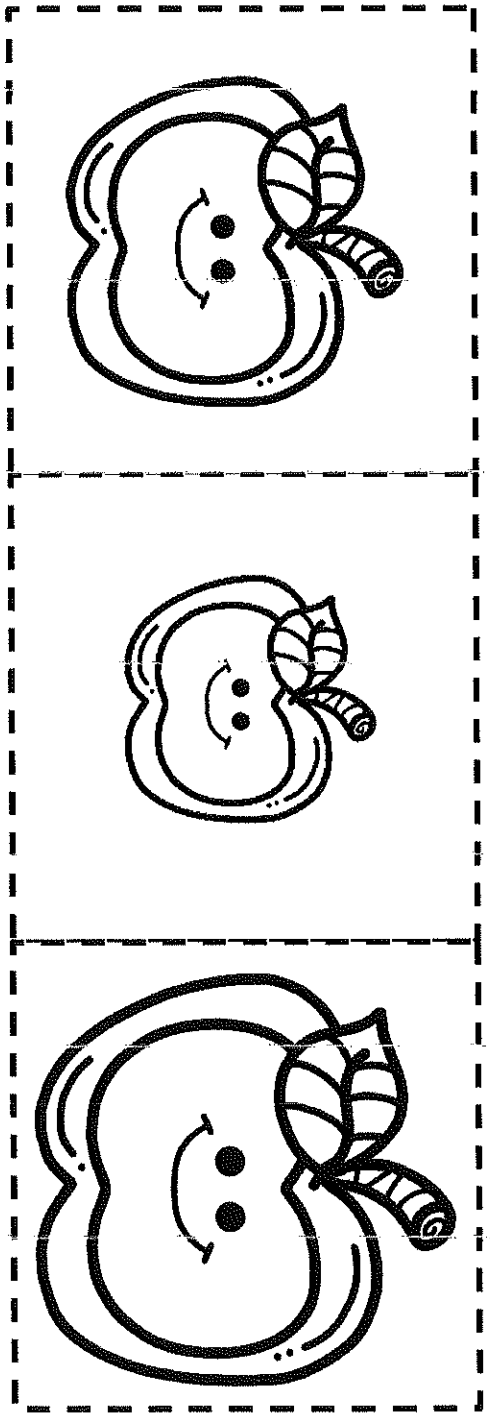

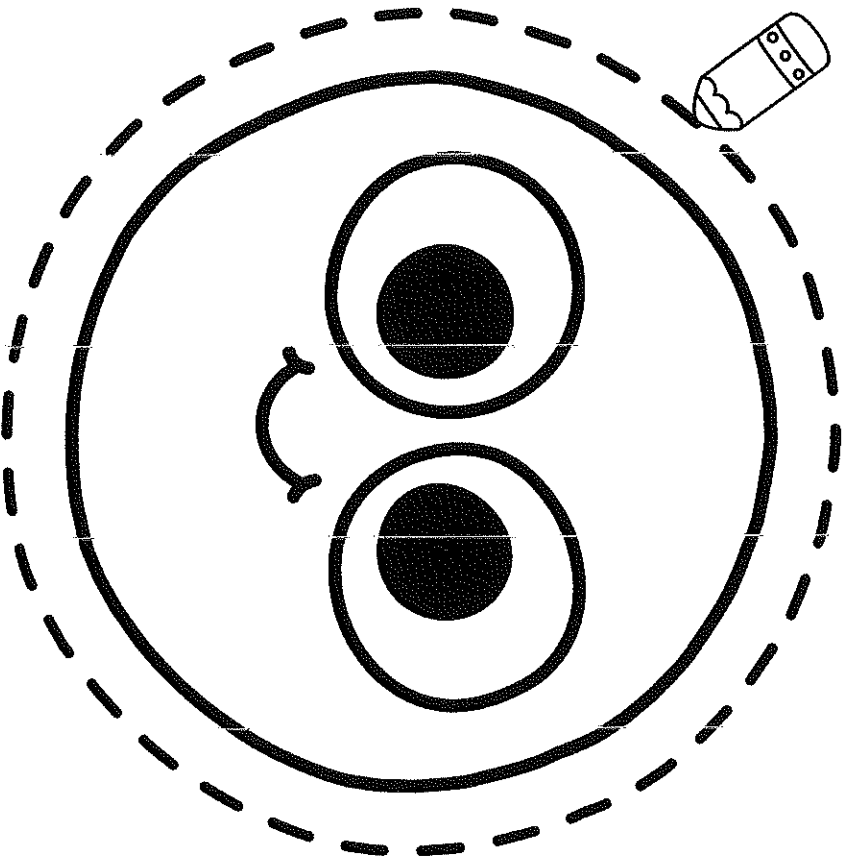

Trace. Color red.

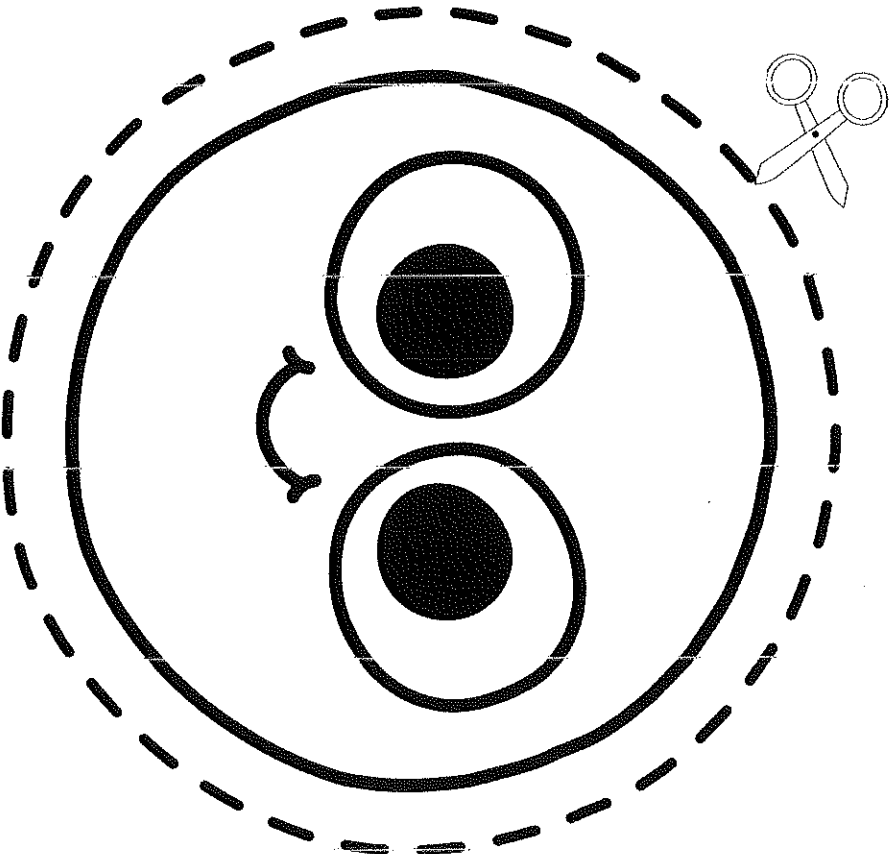
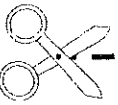

Cut. Color blue.

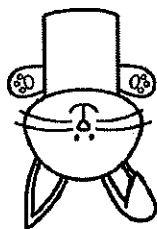
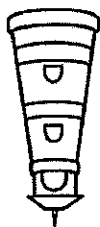
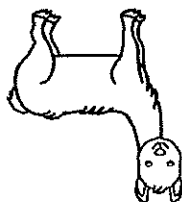

Color the items  
that start with L

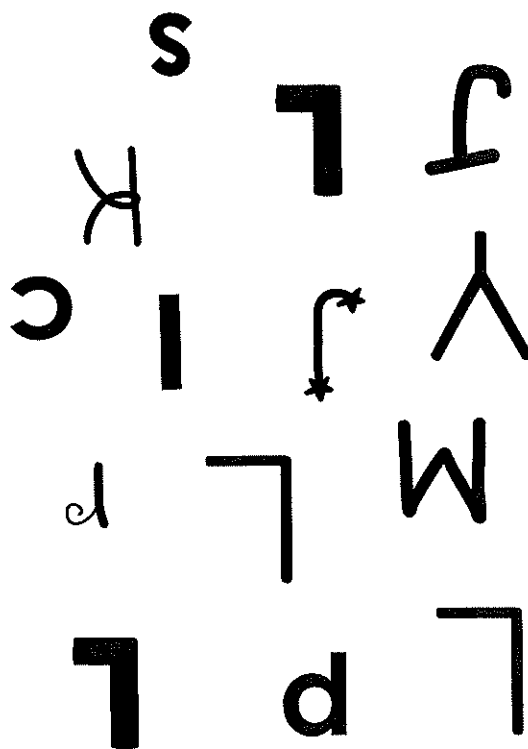

Find and circle L

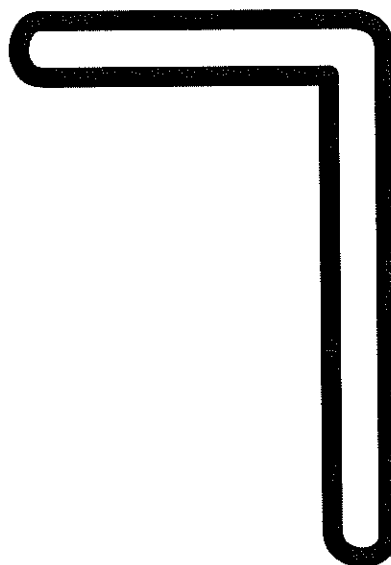

Color the letter

Handwriting practice lines consisting of three sets of solid top and bottom lines with a dashed middle line. The first set is empty, and the second set contains a dotted outline of the letter 'L' for tracing.

Trace and write

Name: \_\_\_\_\_



Name: \_\_\_\_\_

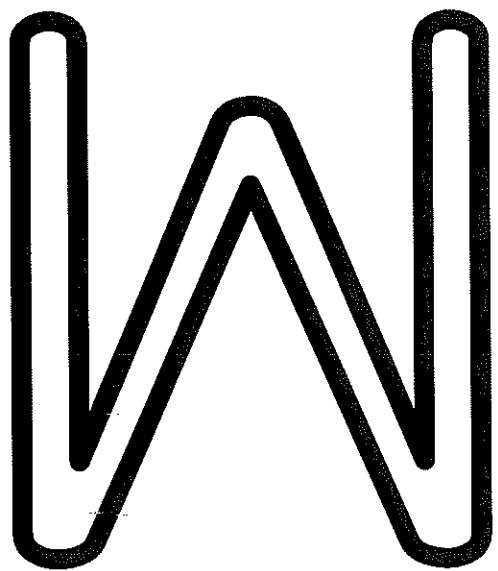

Color the letter

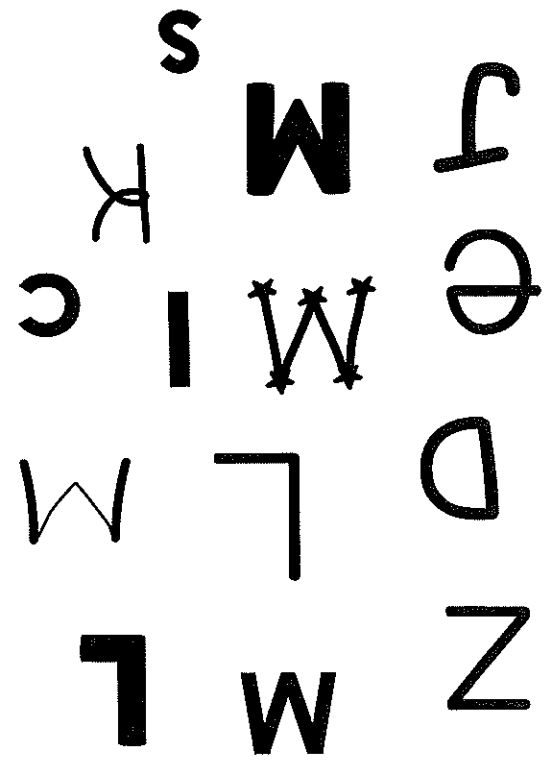

Find and circle M

Color the items that start with M

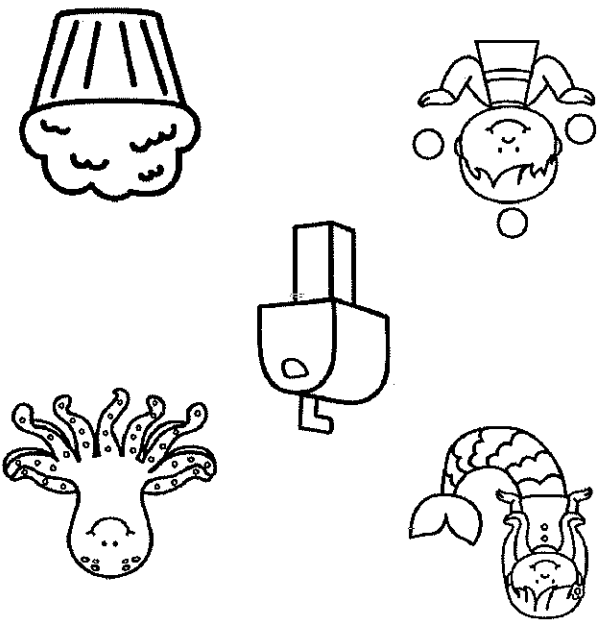

Trace and write

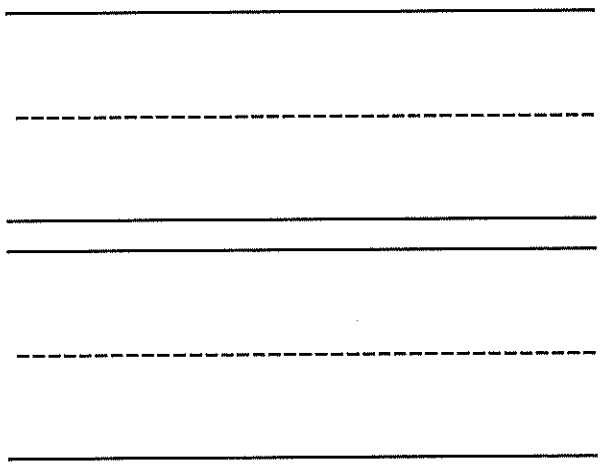
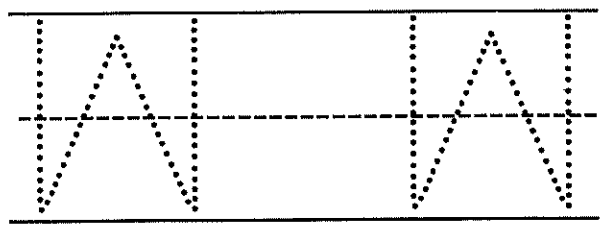

# DAY 3 of NTI Work

Find and circle B

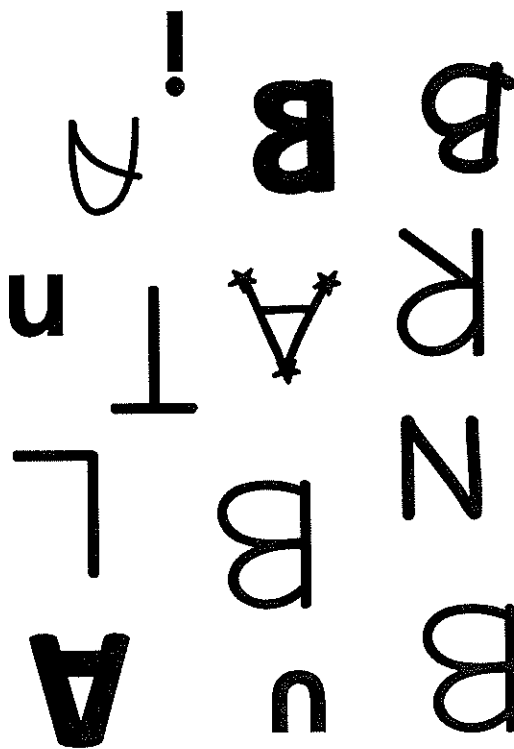

Color the letter

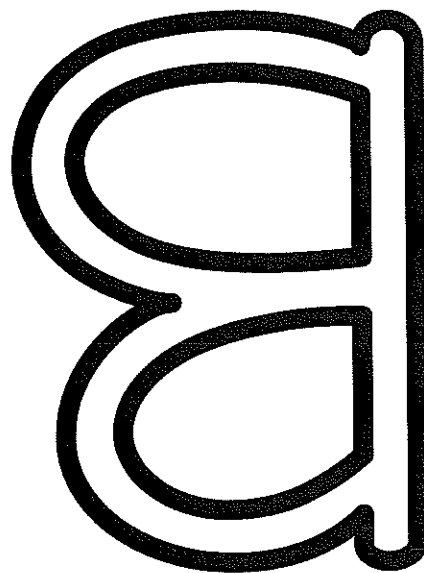

Color the items  
that start with B

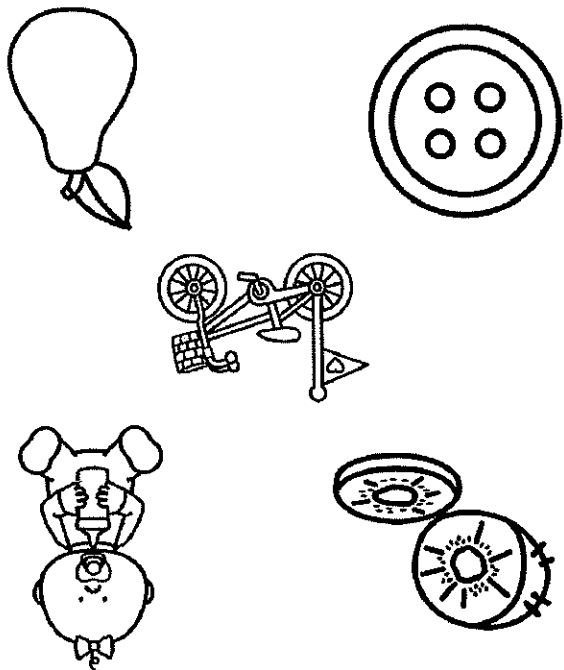

Trace and write

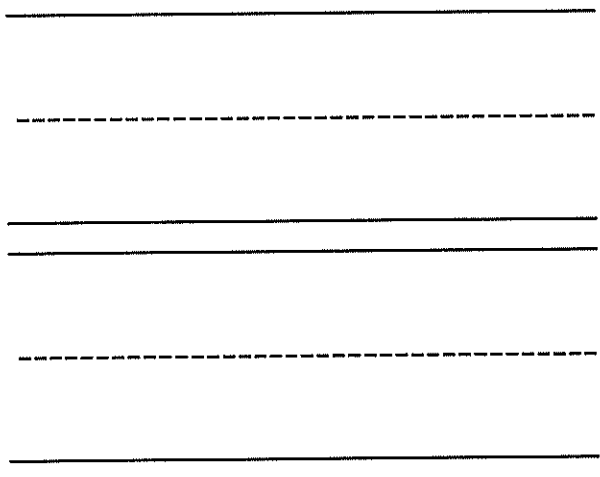
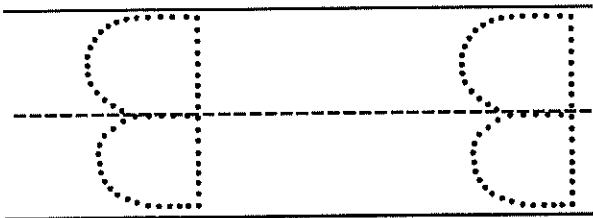

Name: \_\_\_\_\_

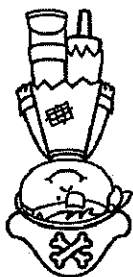
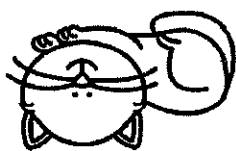
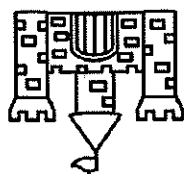

Color the items  
that start with C

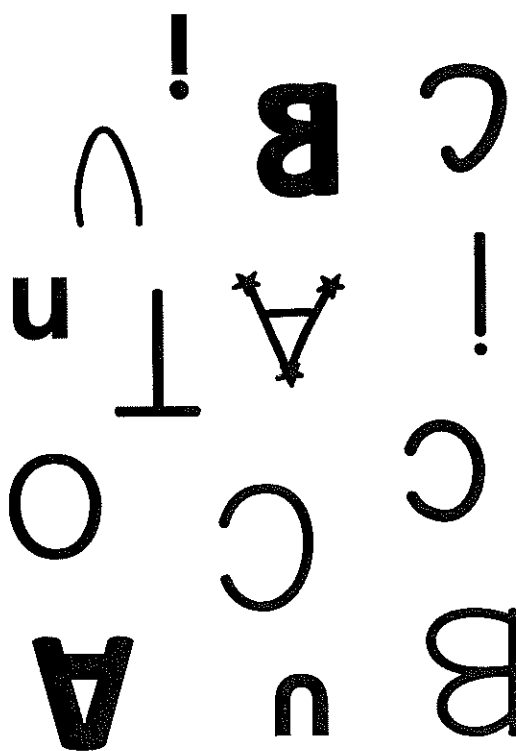

Find and circle C

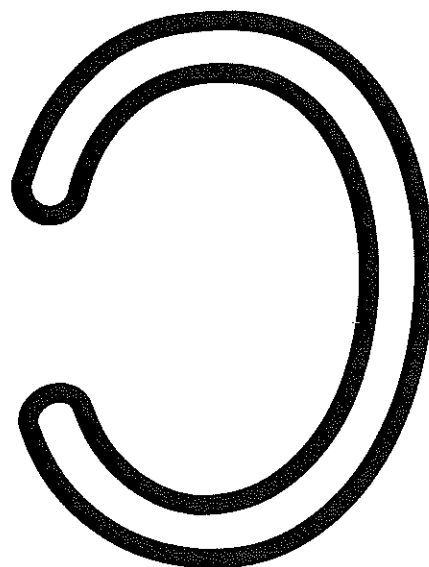

Color the letter

Handwriting practice lines consisting of four sets of solid top and bottom lines with a dashed middle line. The last two sets include dotted letters 'C' for tracing.

Trace and write

Name: \_\_\_\_\_

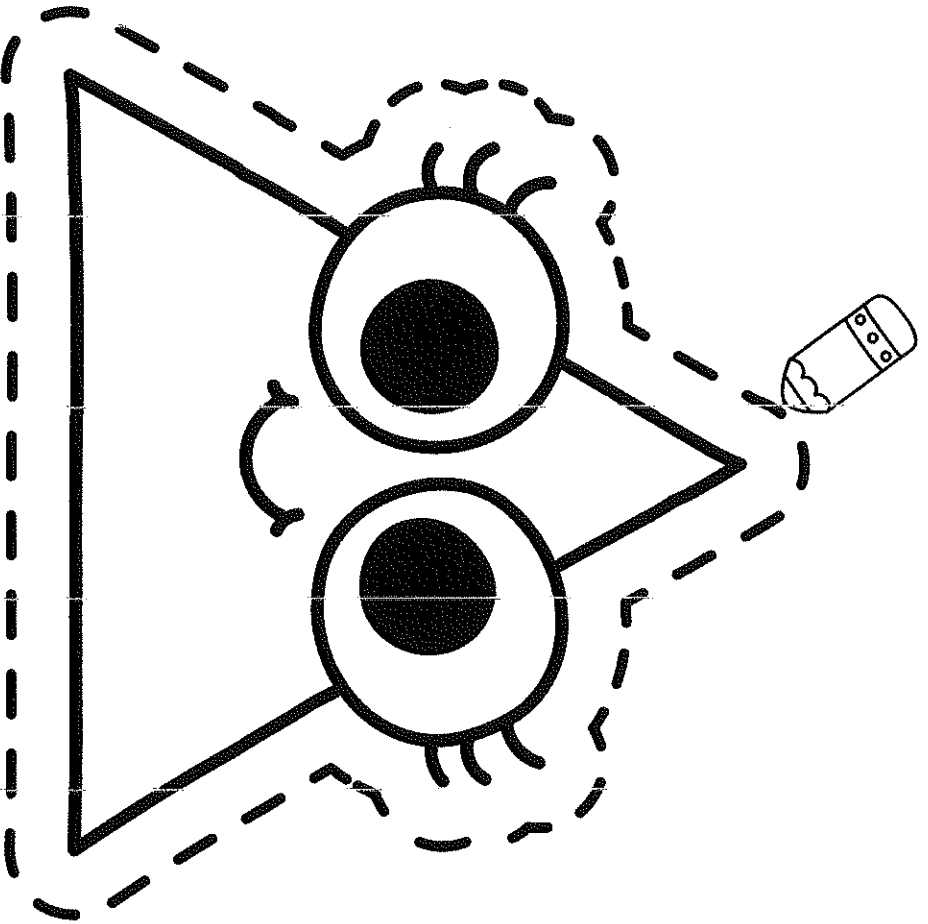

Trace. Color orange.

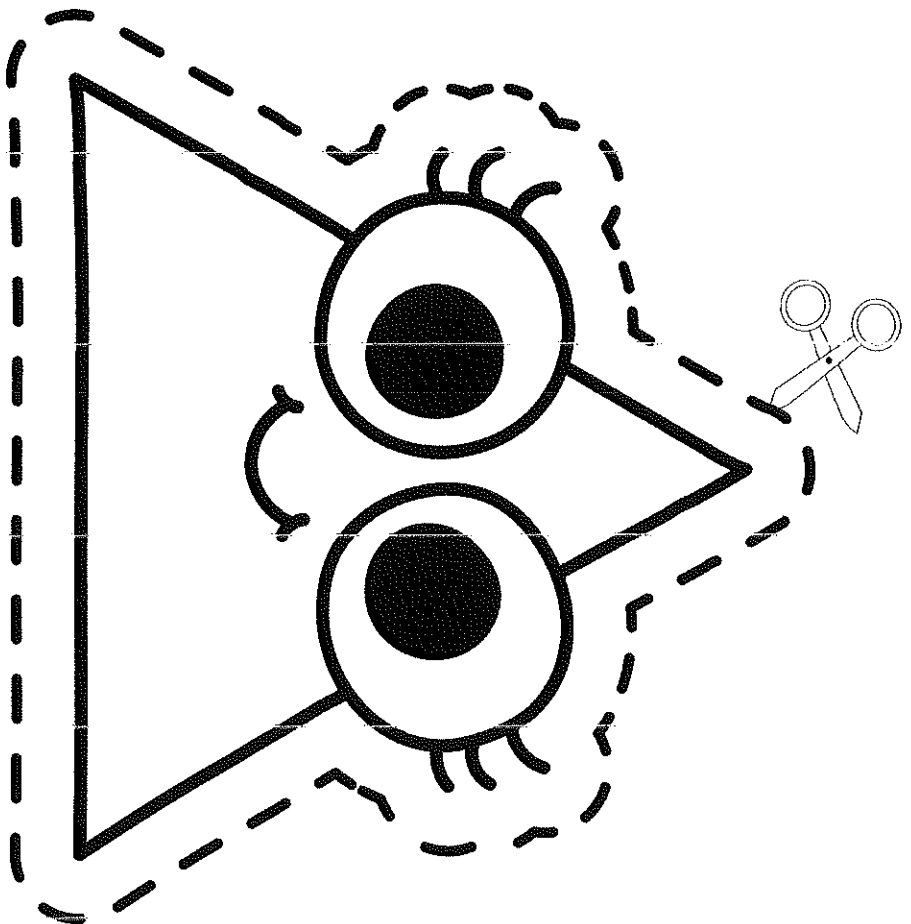

Cut. Color brown.

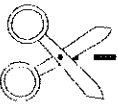

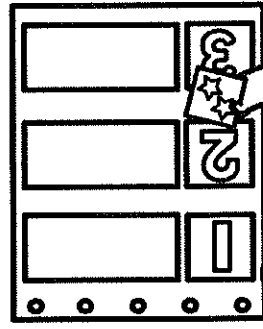

19 20

16 17 18

13 14 15

10 11 12

6 7 8 9

1 2 3 4 5

I CAN WRITE MY NUMBERS!

Cut on the dotted lines

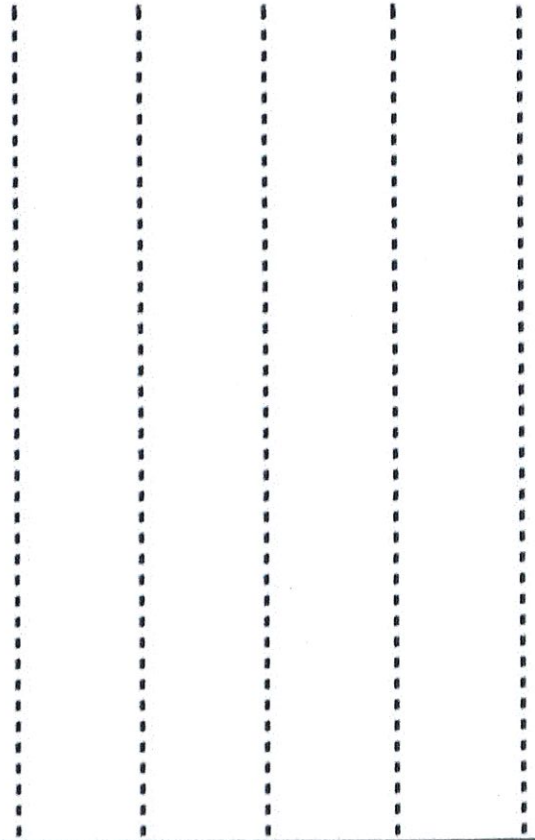
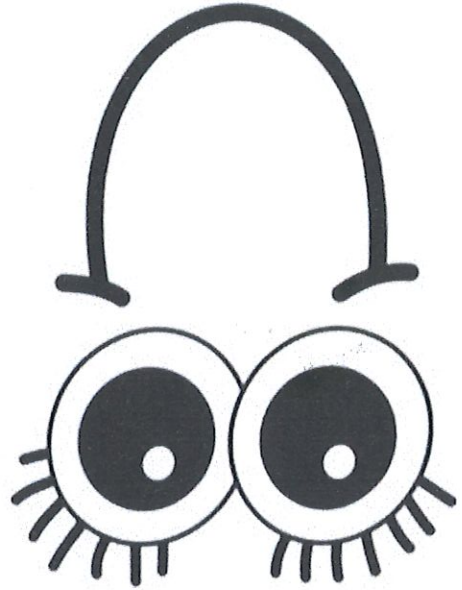
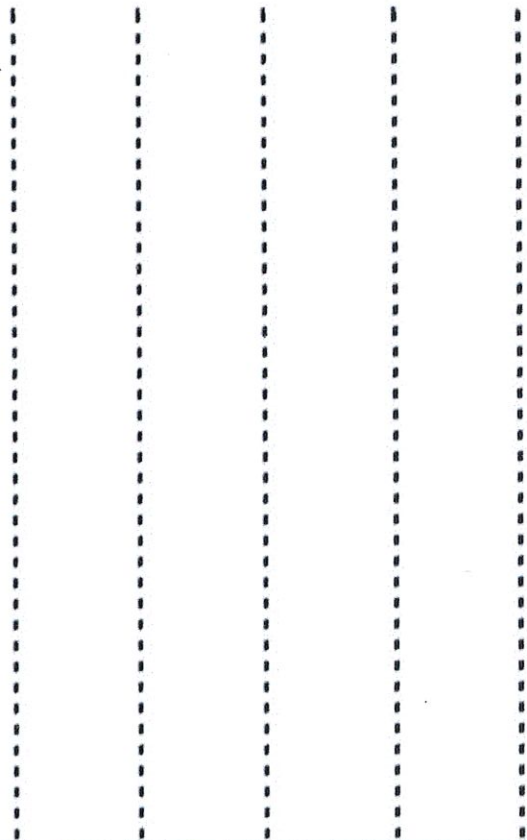
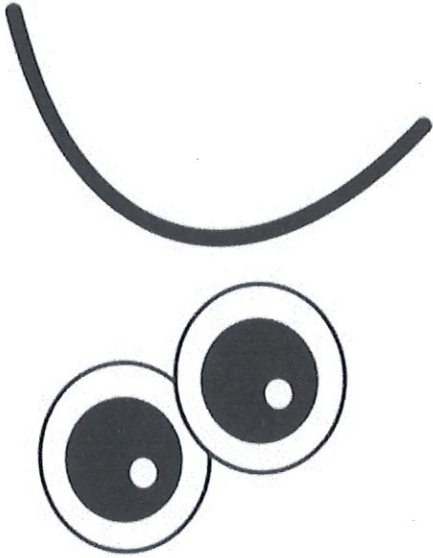

**DAY 4**  
**of NTI**  
**Work**



Name: \_\_\_\_\_

Color the letter

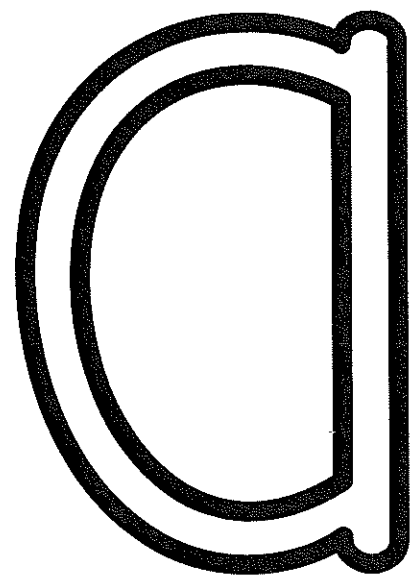

Trace and write

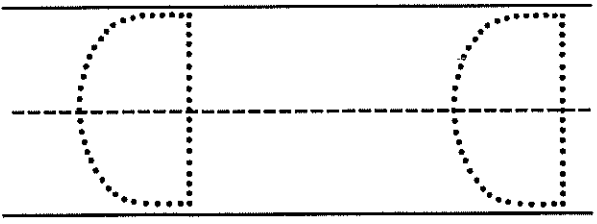

Four sets of handwriting lines (top solid, middle dashed, bottom solid) for writing practice.

Find and circle D

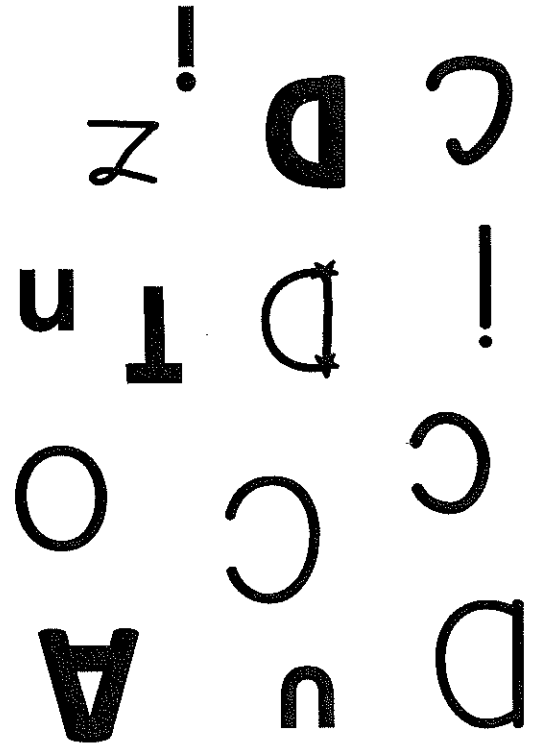

Color the items that start with D

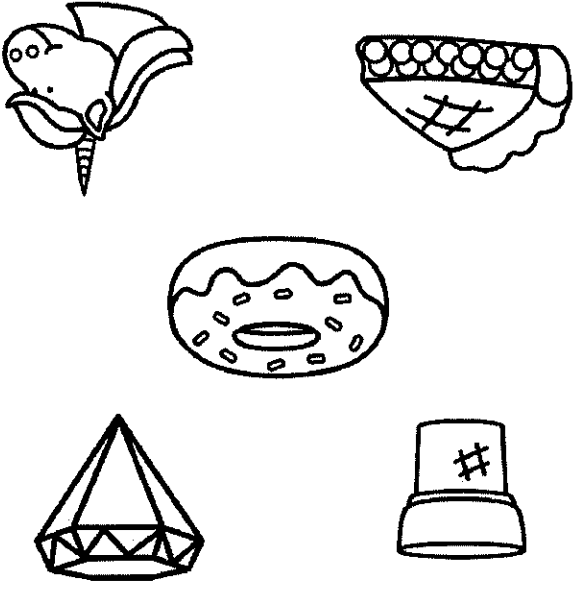

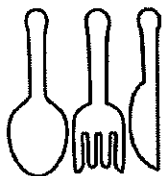
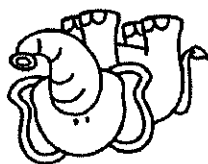
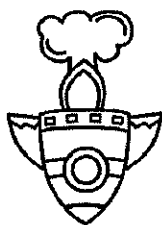
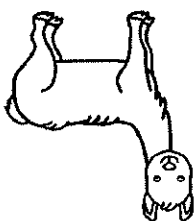

Color the items  
that start with E

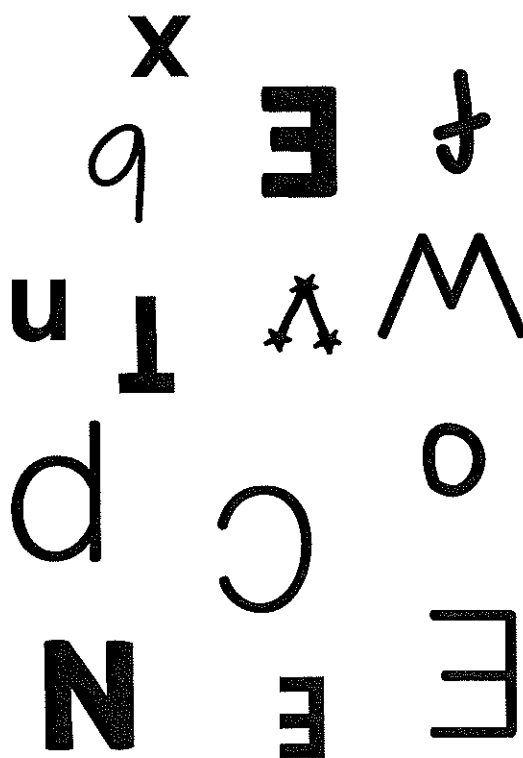

Find and circle E

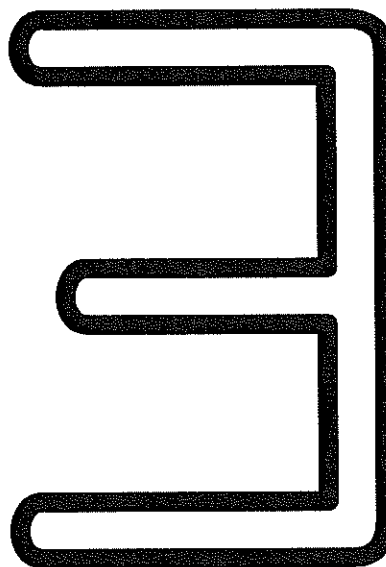

Color the letter

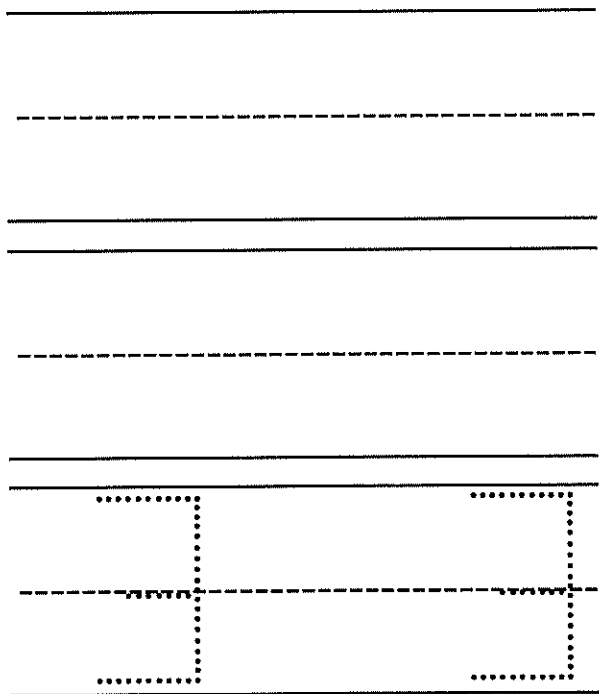

Trace and write

Name: \_\_\_\_\_

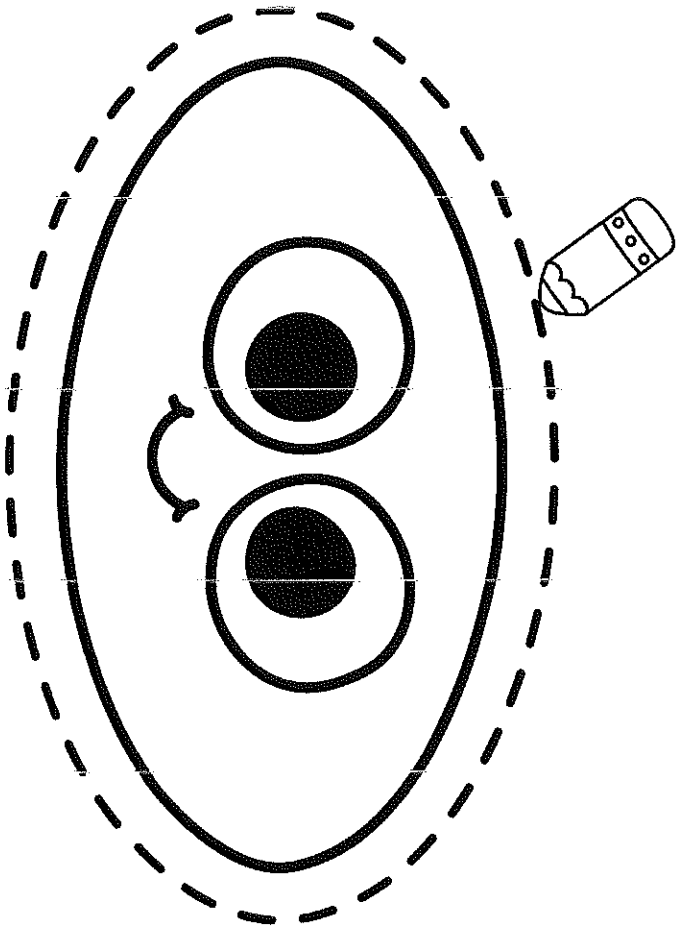

Trace. Color gray.

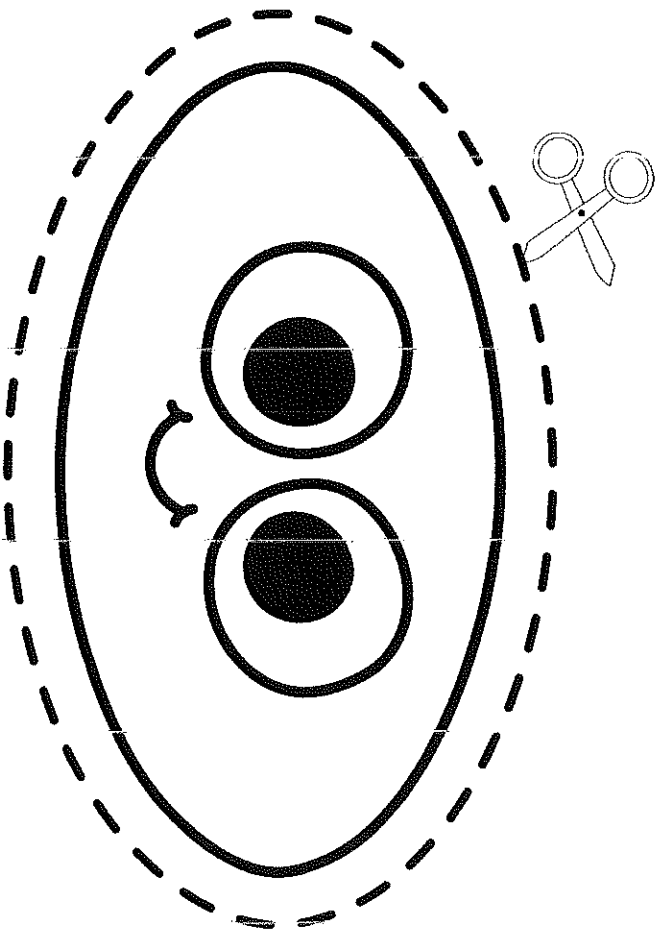
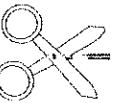

Cut. Color gray.

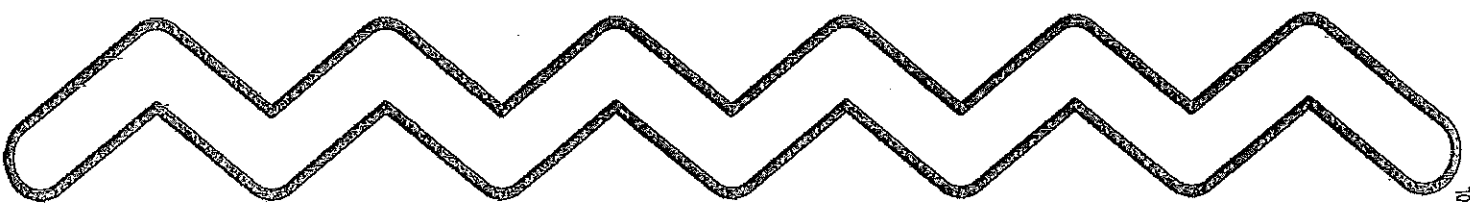
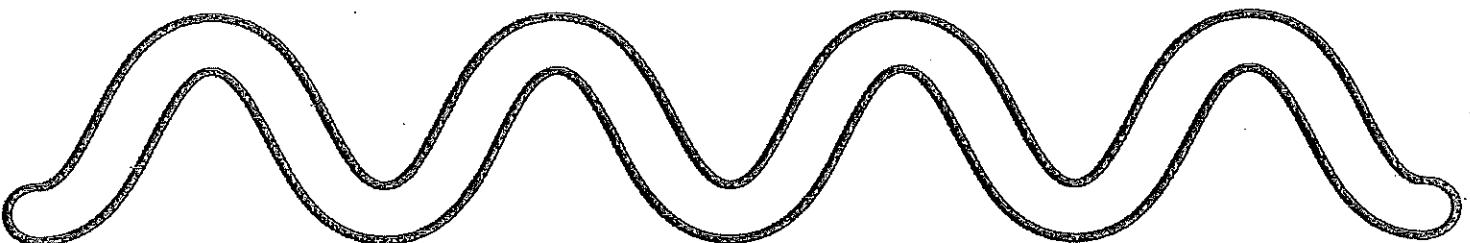
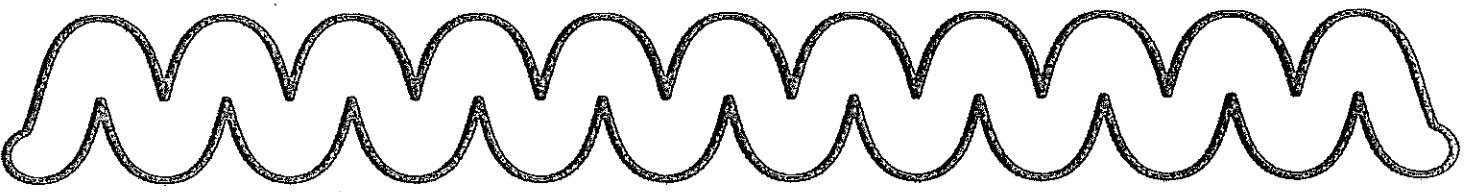
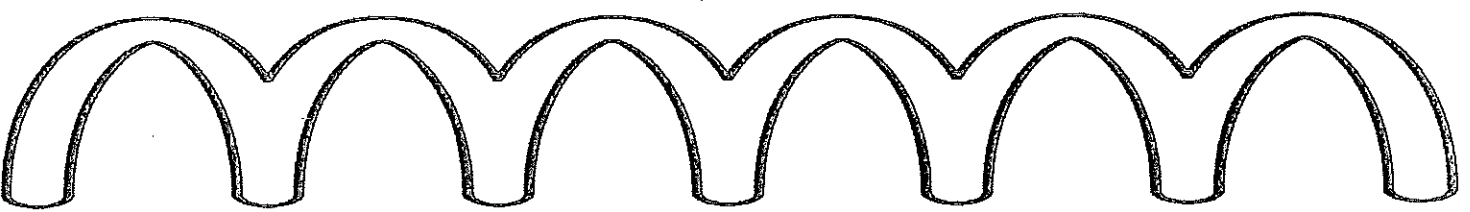
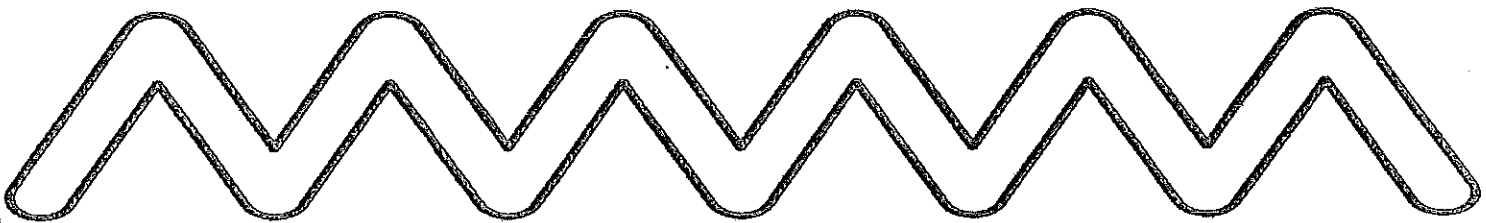
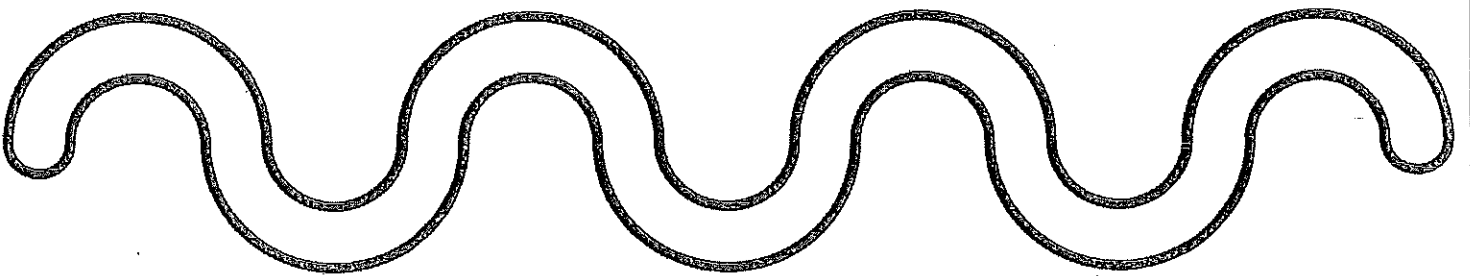
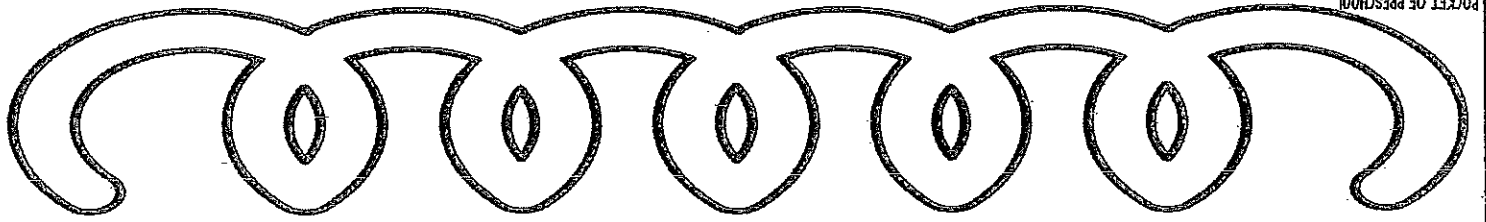

**Make and Trace the lines!**  
Place in a page protector. Make the lines with dry beans or trace with a marker.

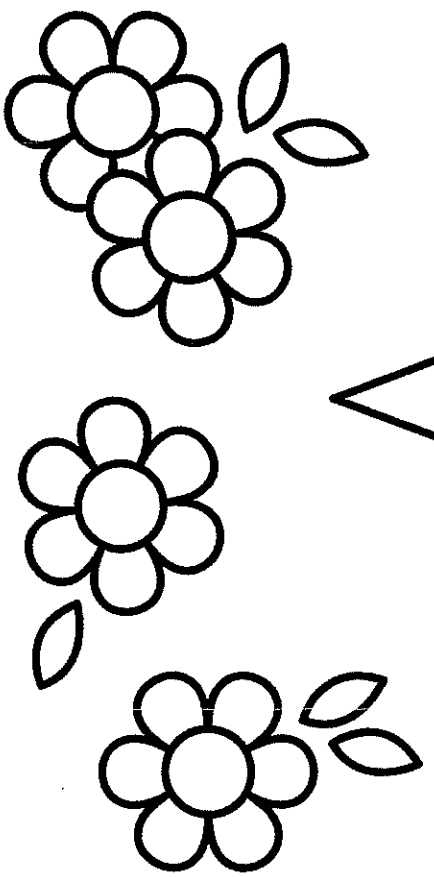
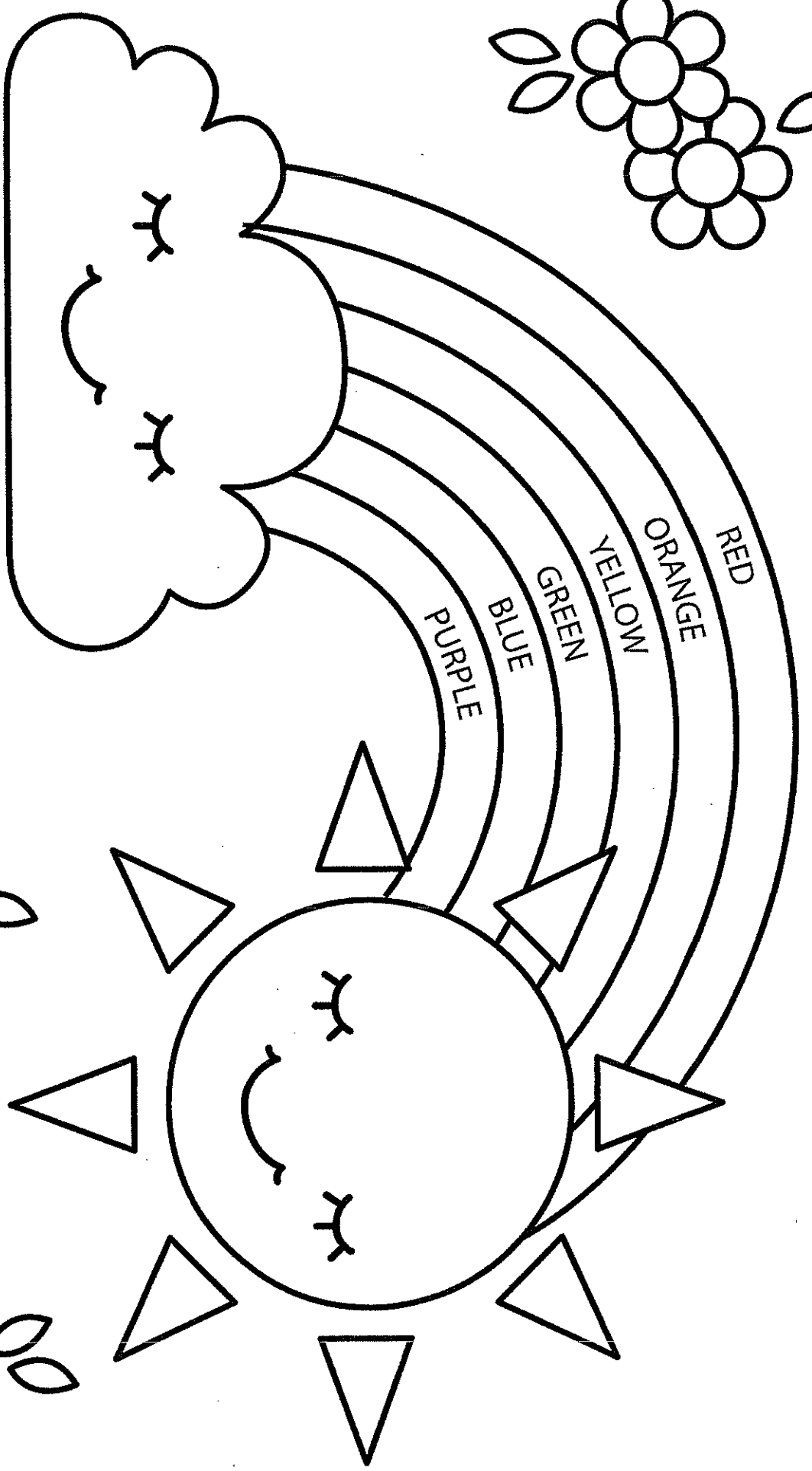
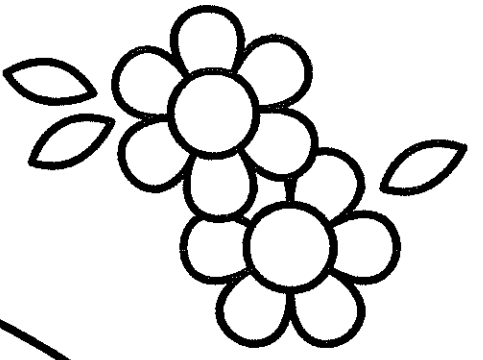

Name \_\_\_\_\_

**DAY 5**

**of NTI**

**Work**

Name: \_\_\_\_\_

Color the letter

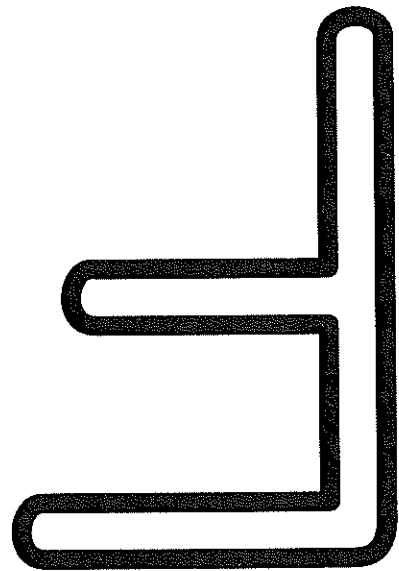

Trace and write

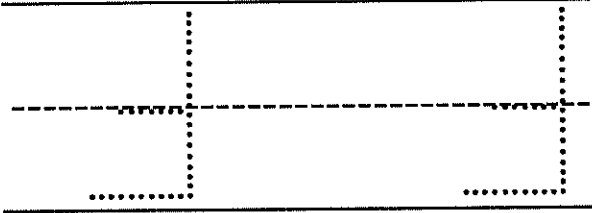

Handwriting practice lines consisting of four sets of three horizontal lines (top, dashed middle, bottom) for writing practice.

Find and circle F

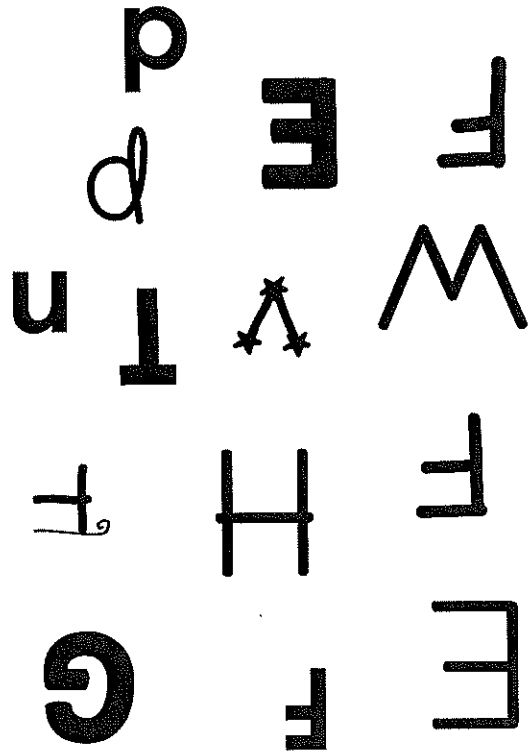

Color the items that start with F

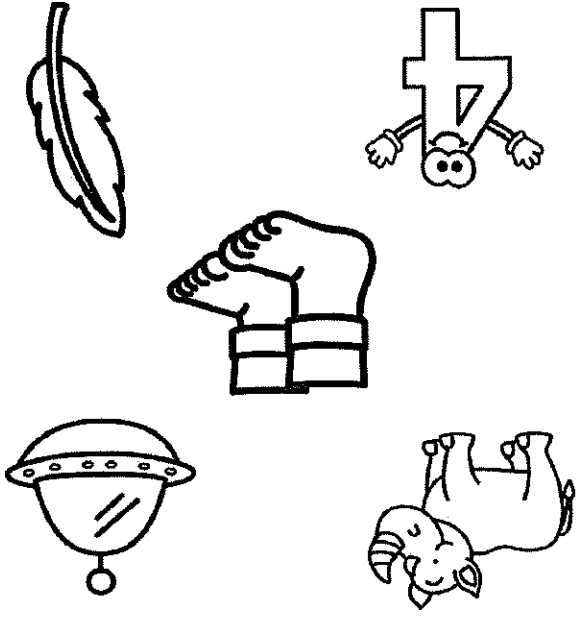

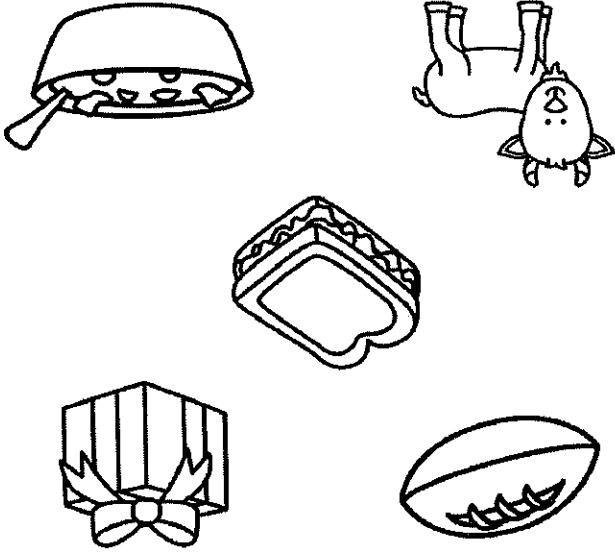

Color the items  
that start with G

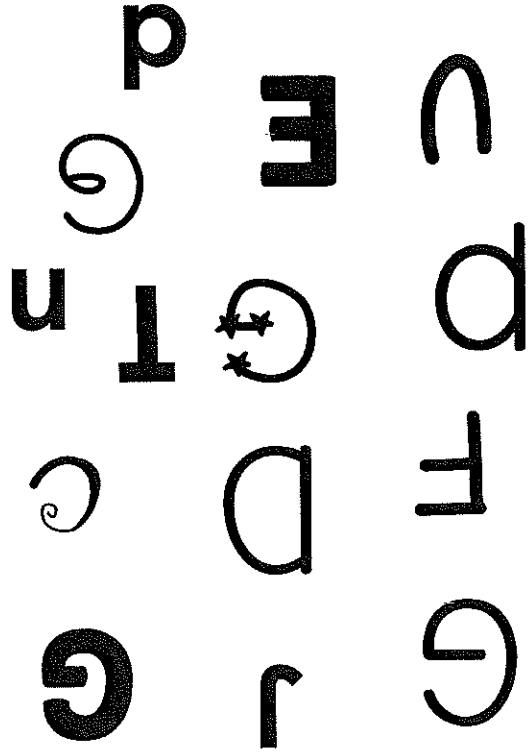

Find and circle G

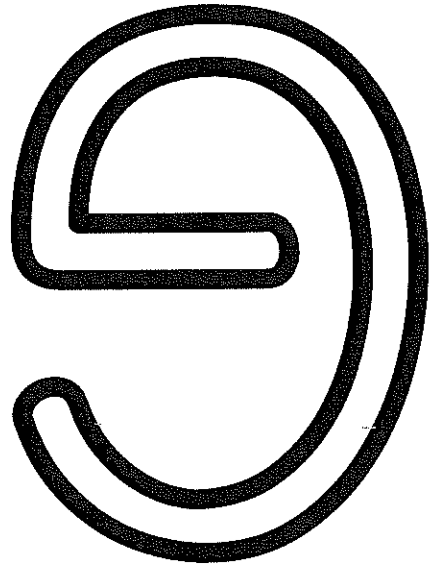

Color the letter

Tracing practice lines consisting of four sets of three horizontal lines (top, dashed middle, bottom). The first two sets are blank. The last two sets contain a dotted uppercase letter 'G' for tracing.

Trace and write

Name: \_\_\_\_\_



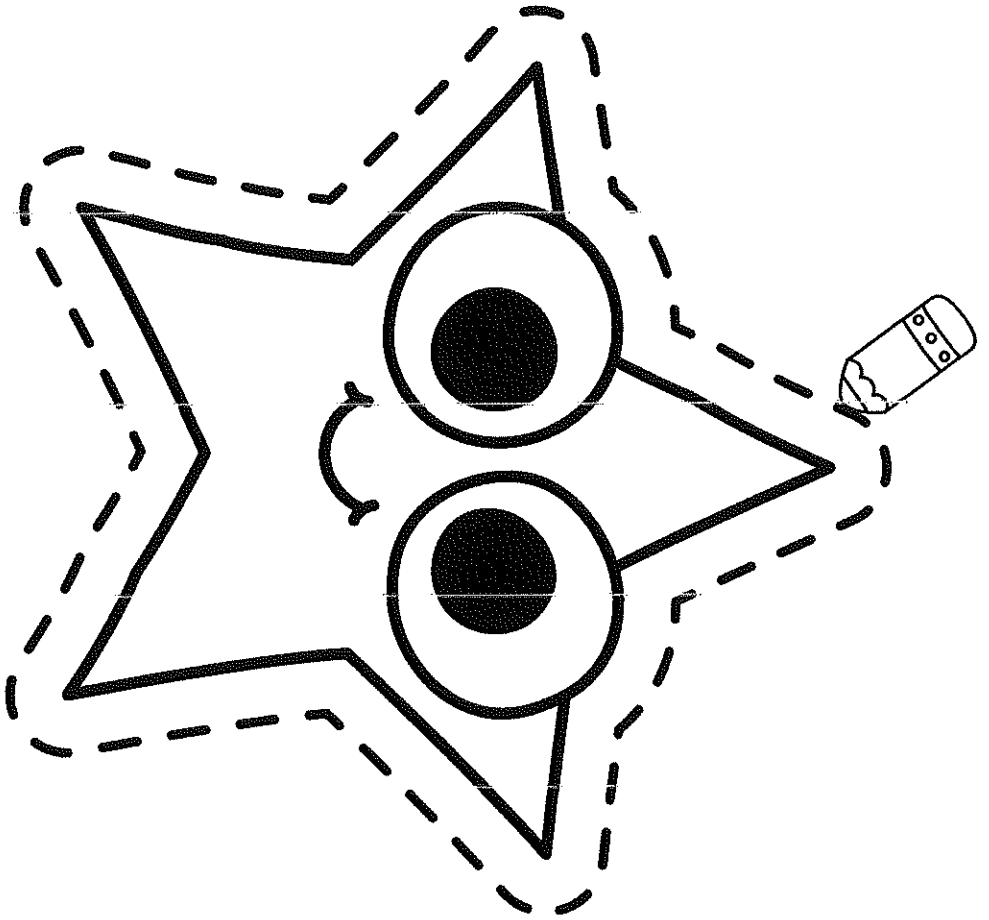

Trace. Color yellow.

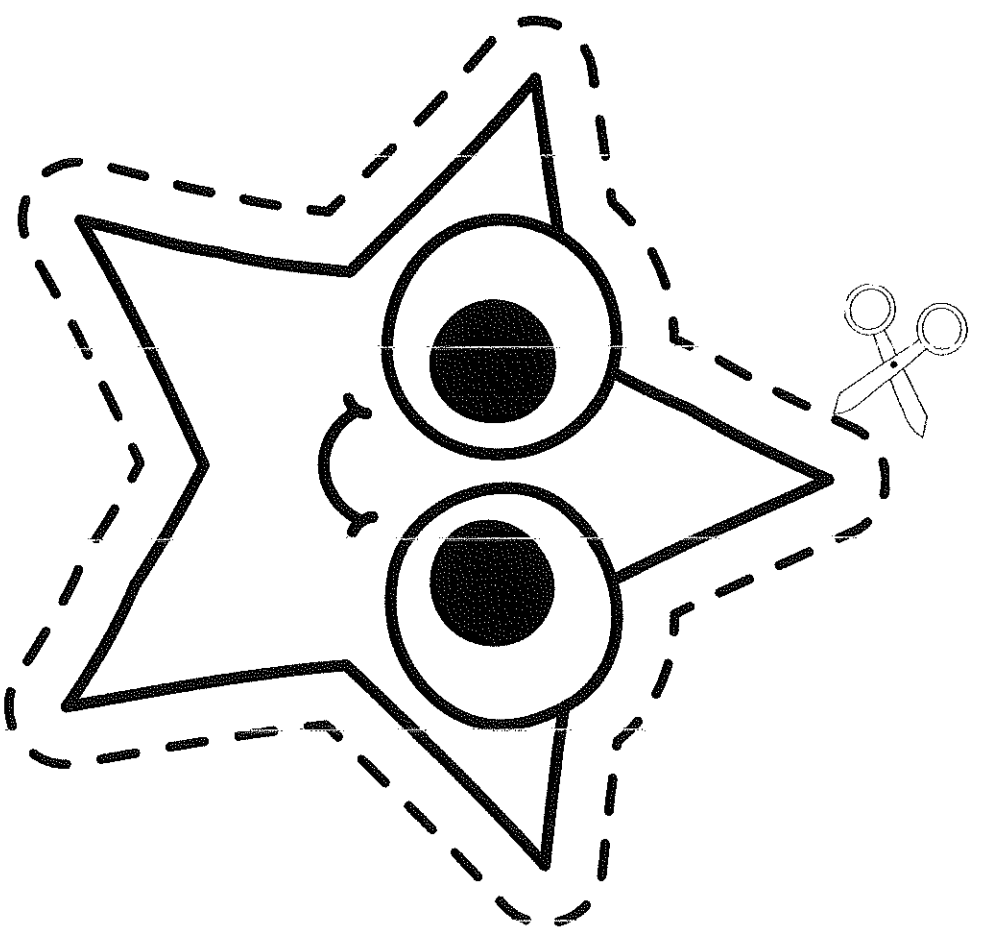
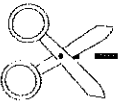

Cut. Color yellow.

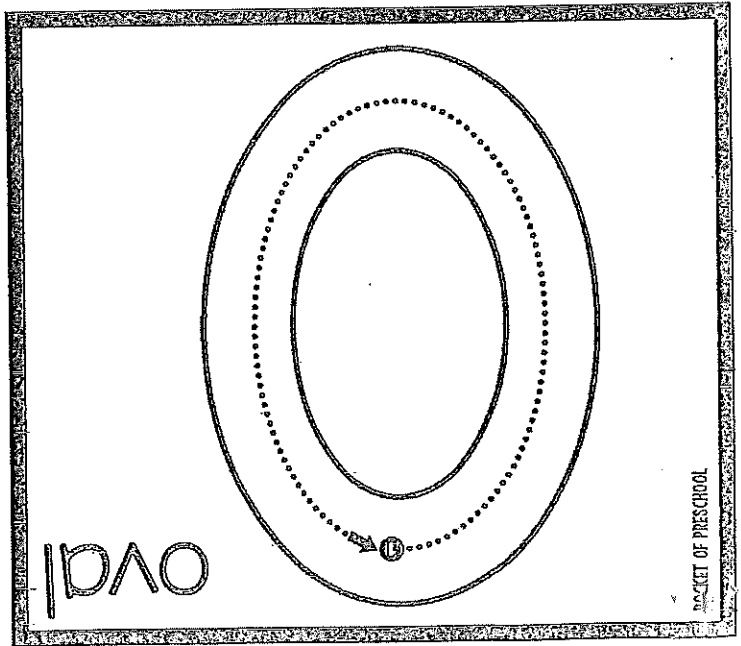
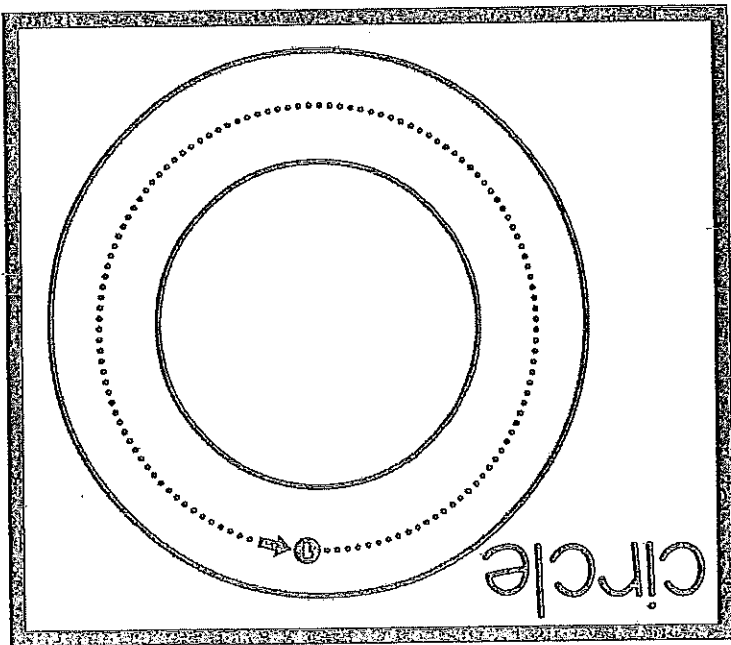
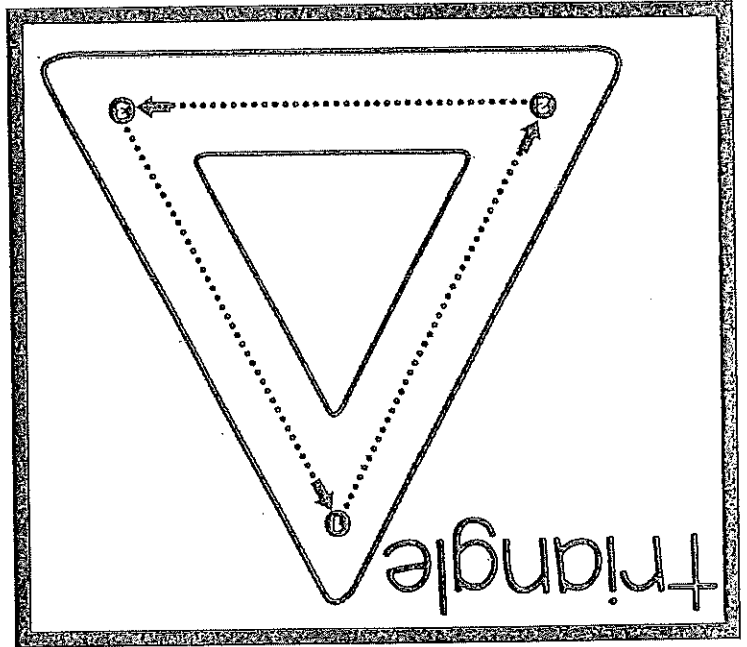
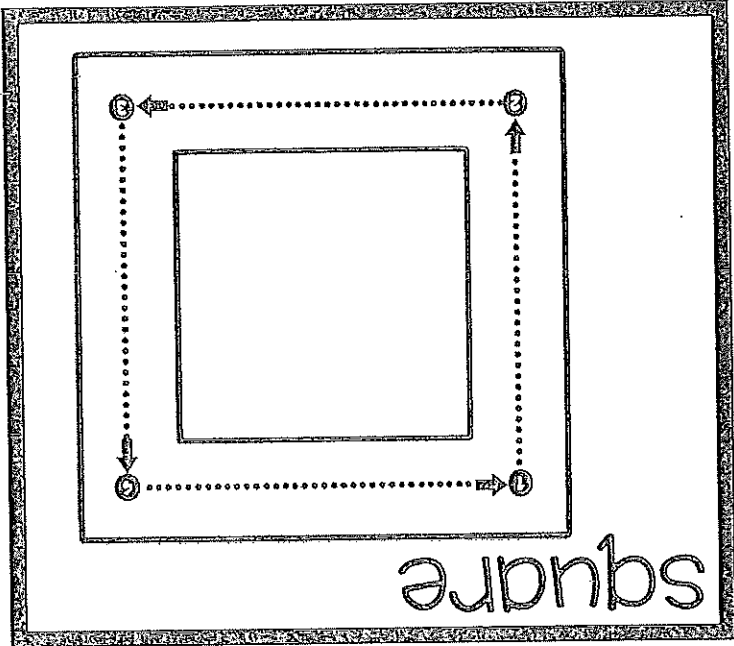
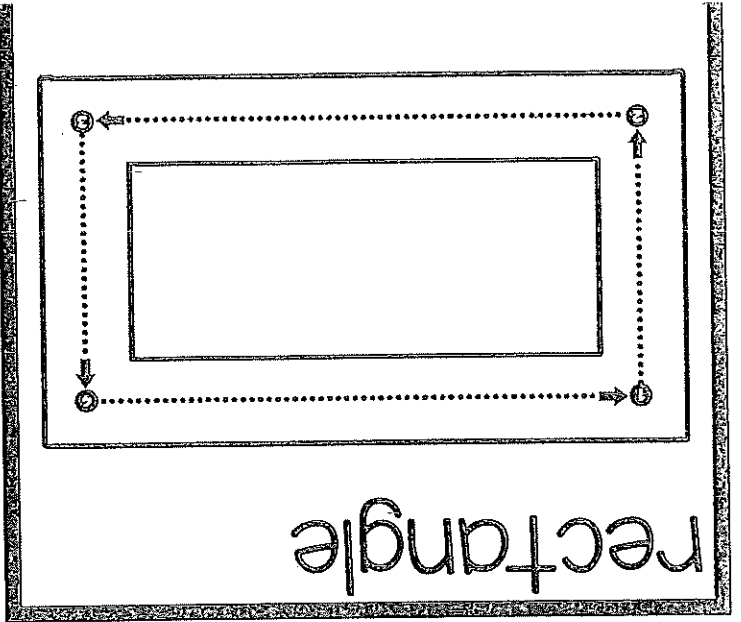
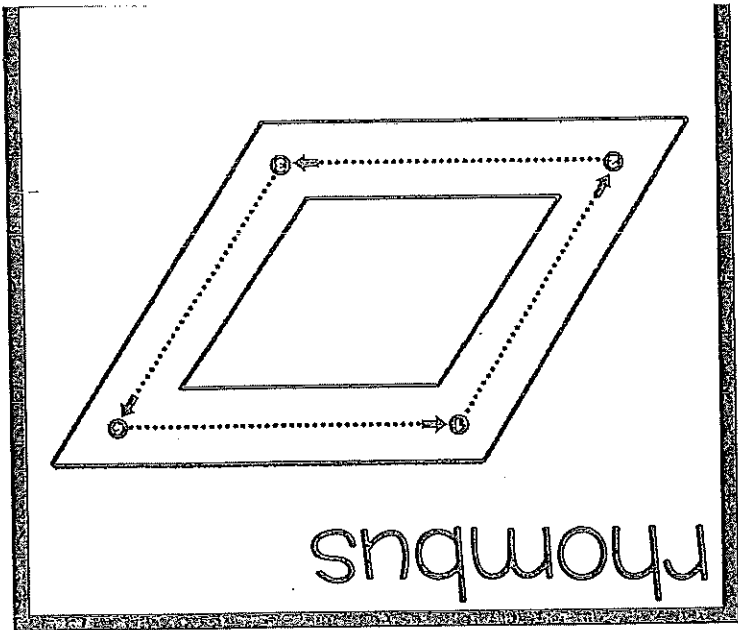

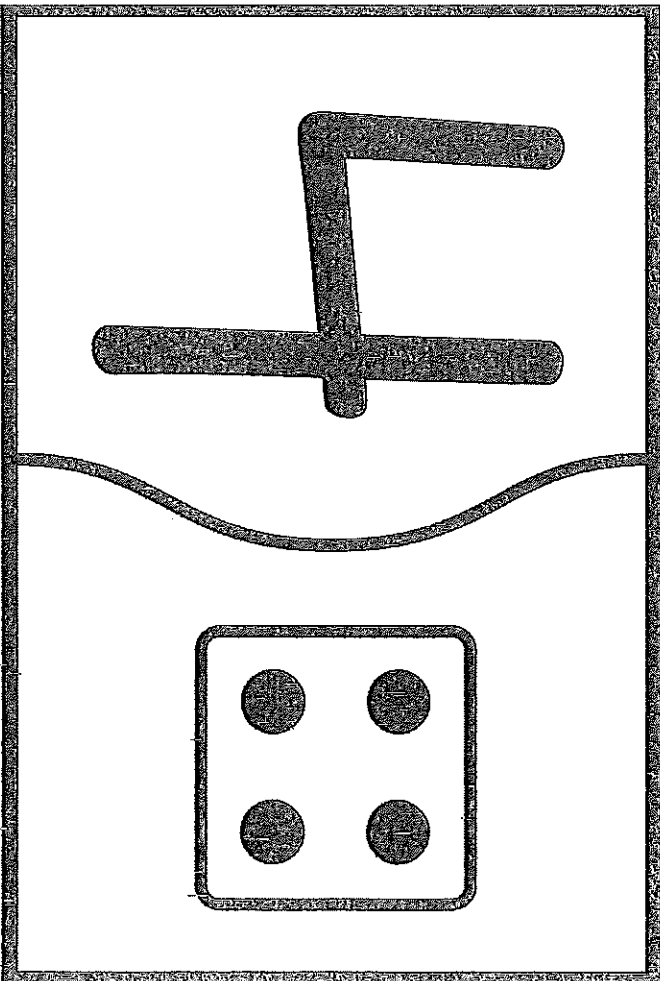
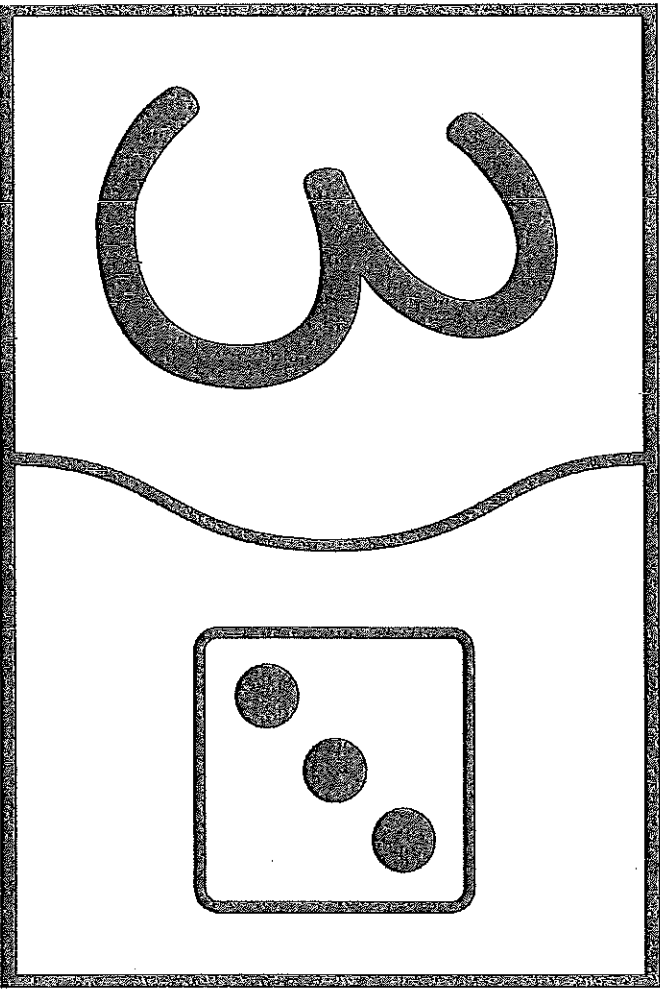
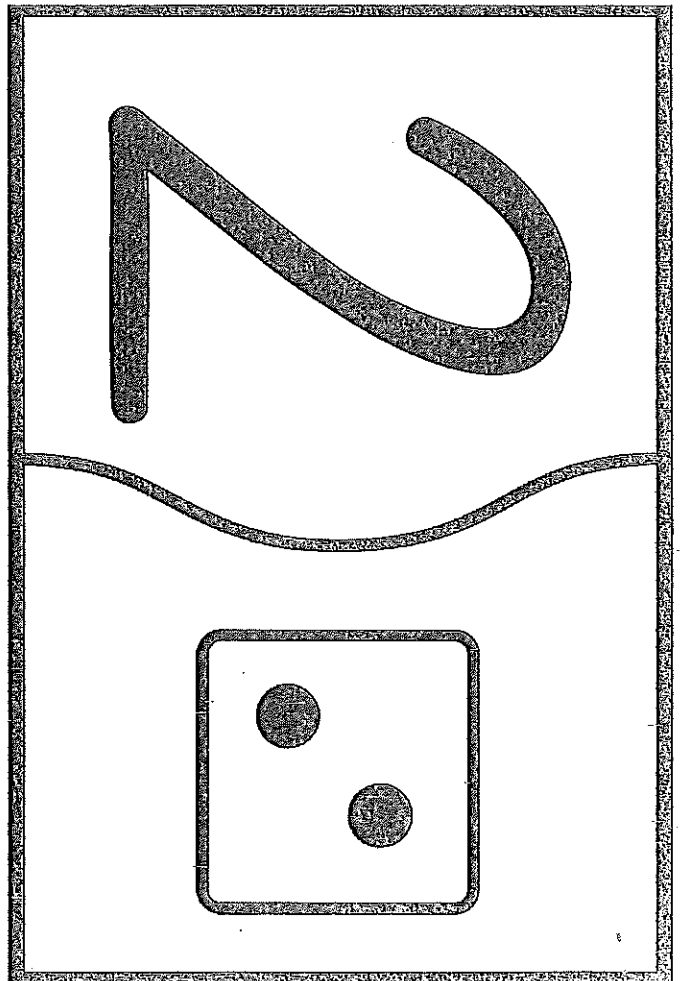
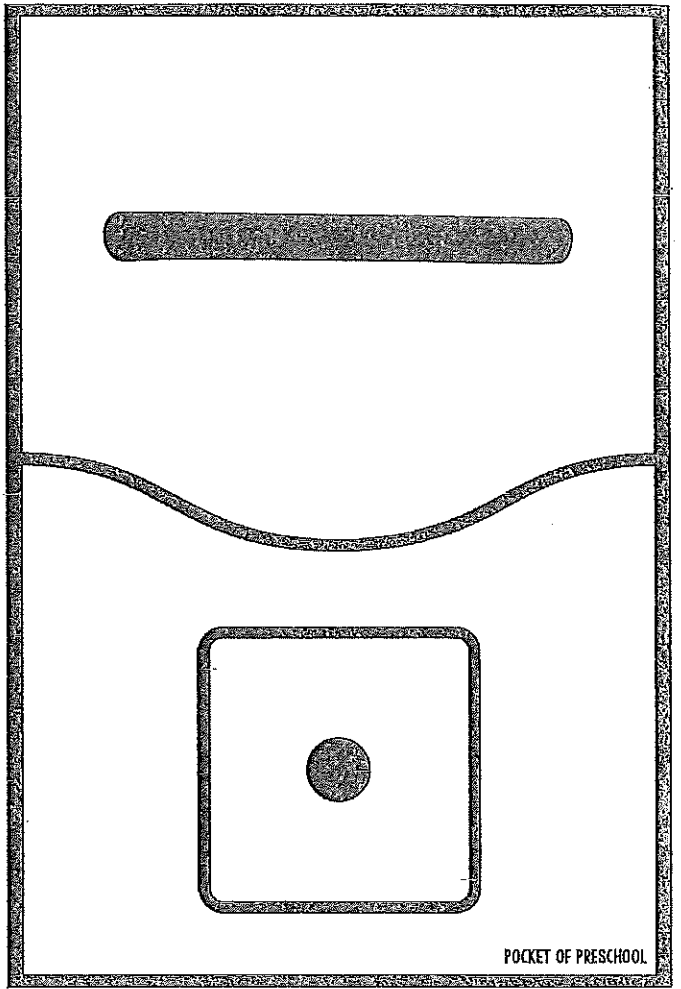

Cut out each puzzle. If doing all the number puzzles at once is overwhelming for your child, try just putting out 5-10 number puzzles at a time.

# DAY 6 of NTI Work

Name: \_\_\_\_\_

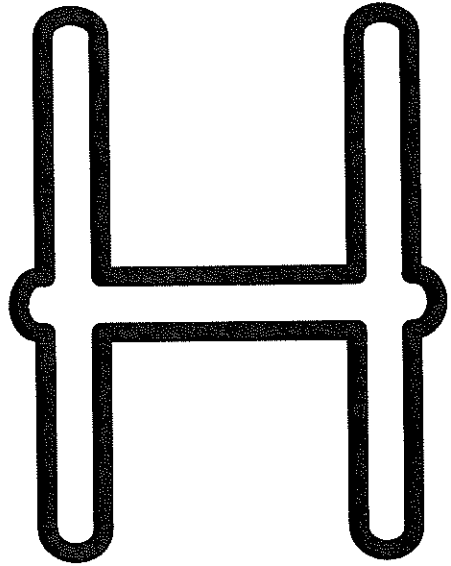

Color the letter

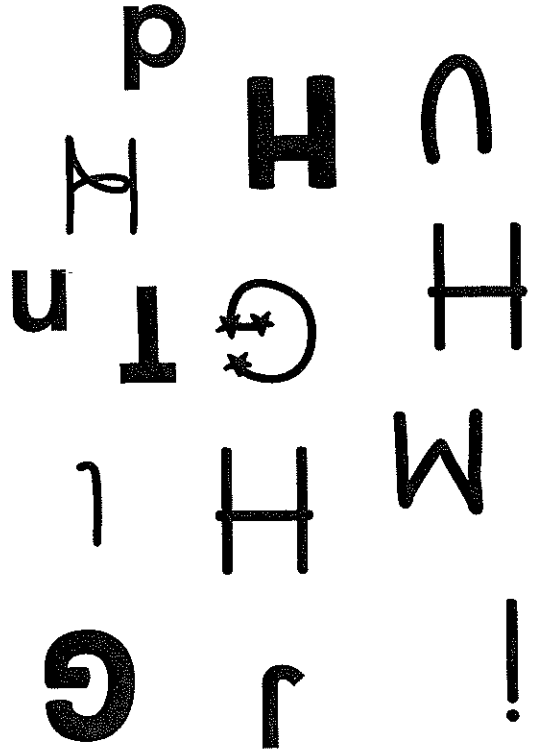

Find and circle H

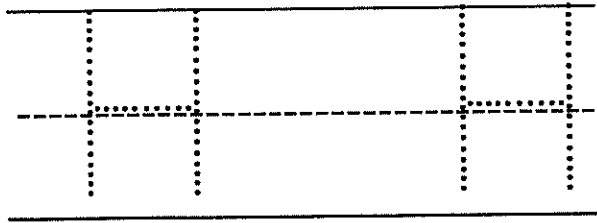

Trace and write

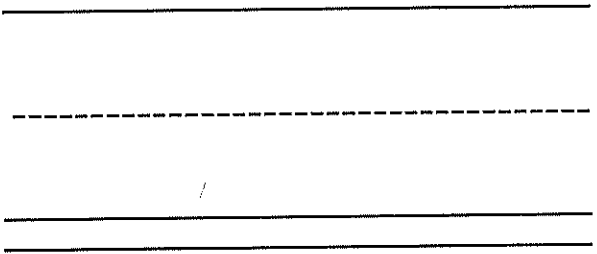

Color the items that start with H

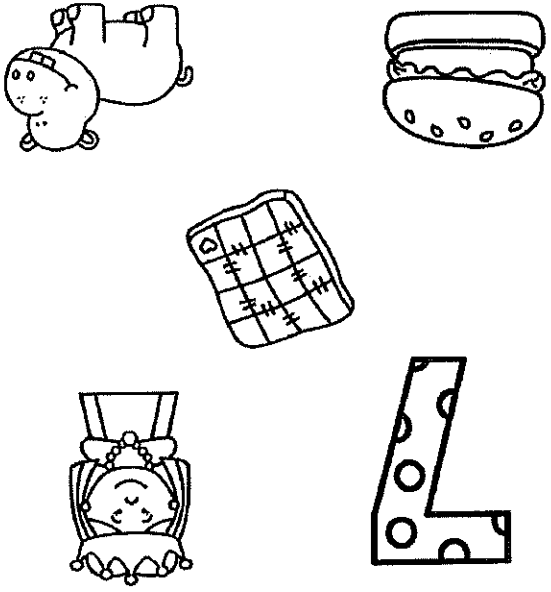

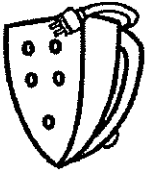
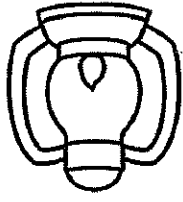
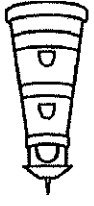

Color the items  
that start with i

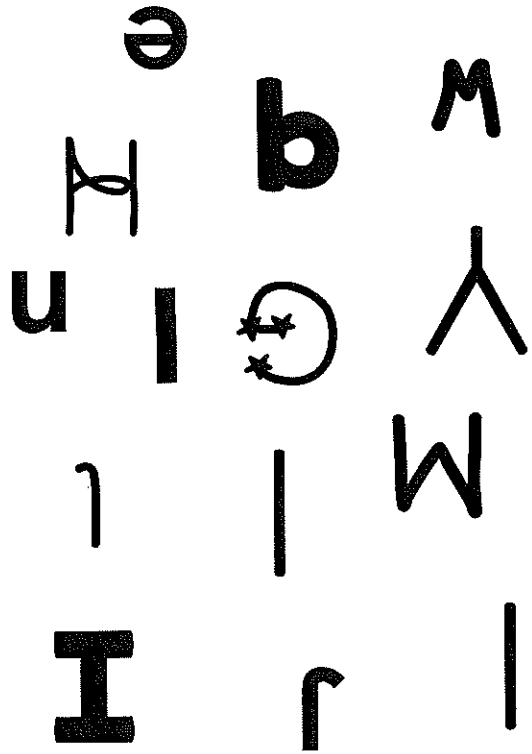

Find and circle i

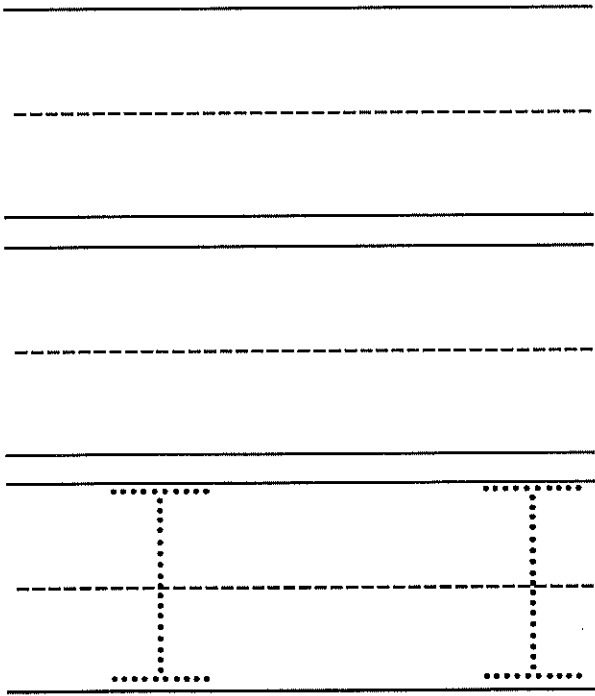

Trace and write

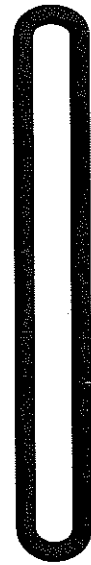

Color the letter

Name: \_\_\_\_\_

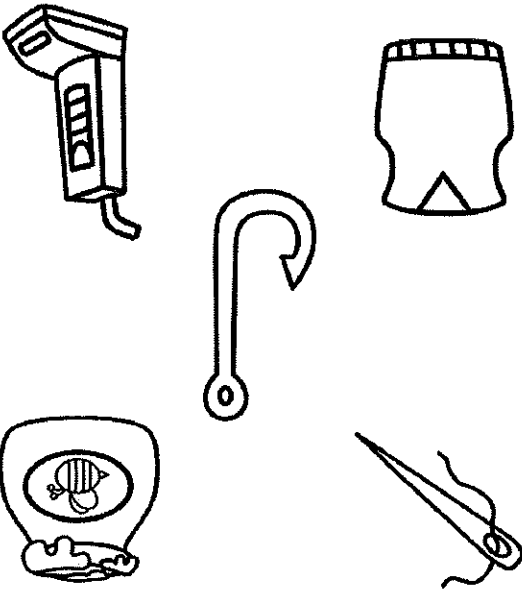

Color the items  
that start with V

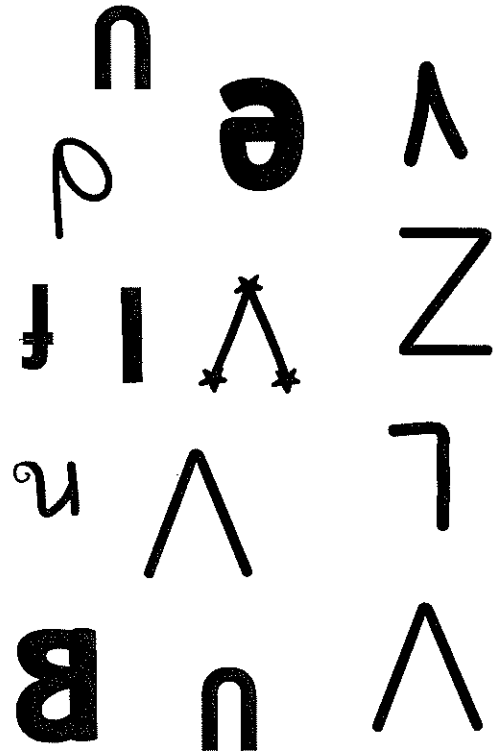

Find and circle V

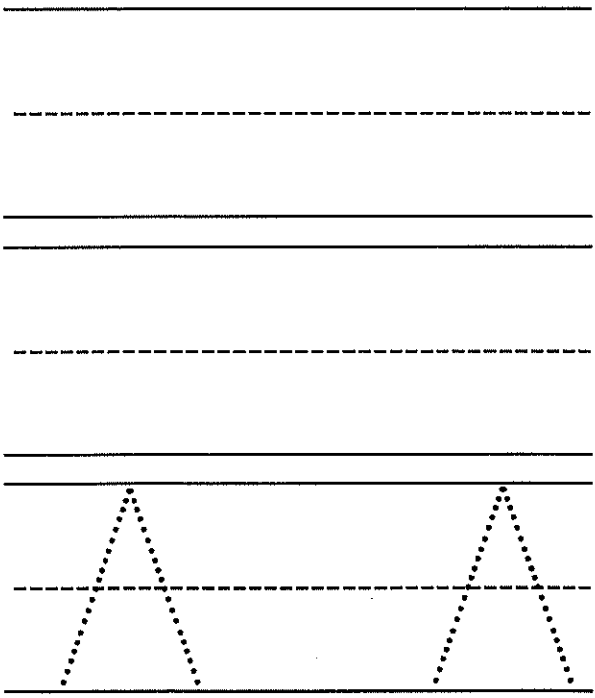

Trace and write

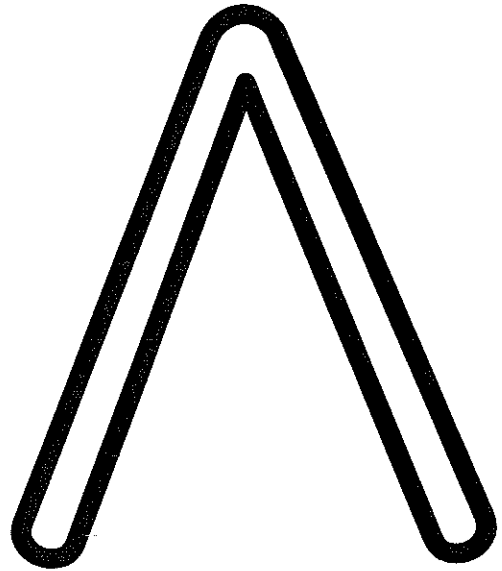

Color the letter

Name: \_\_\_\_\_

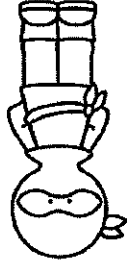
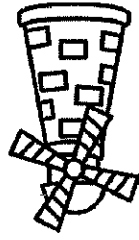
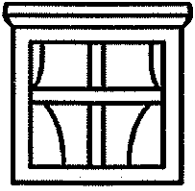

Color the items  
that start with W

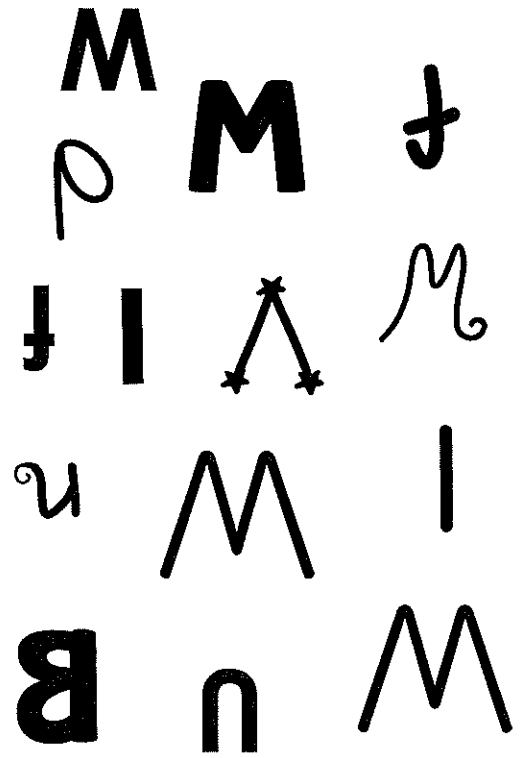

Find and circle W

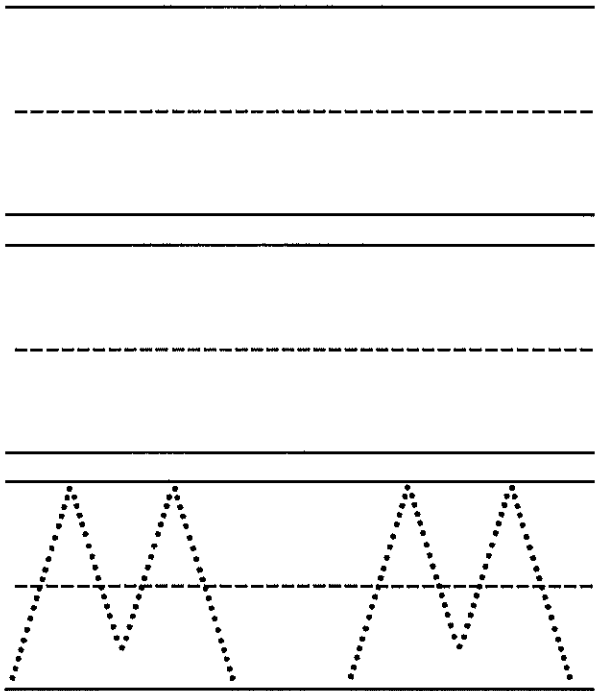

Trace and write

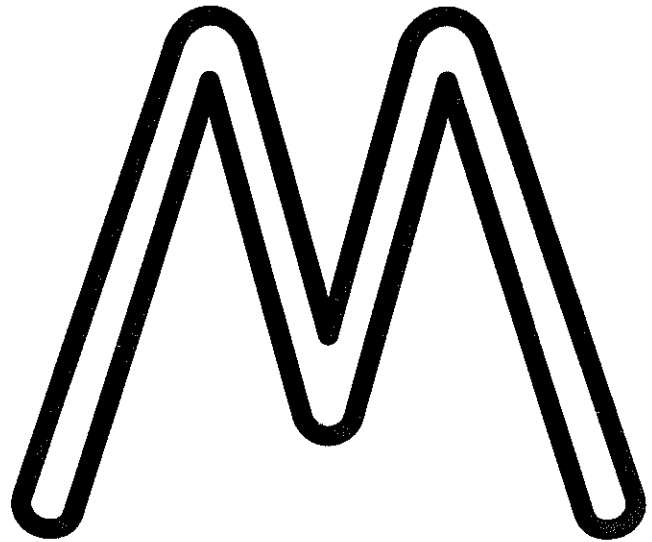

Color the letter

Name: \_\_\_\_\_



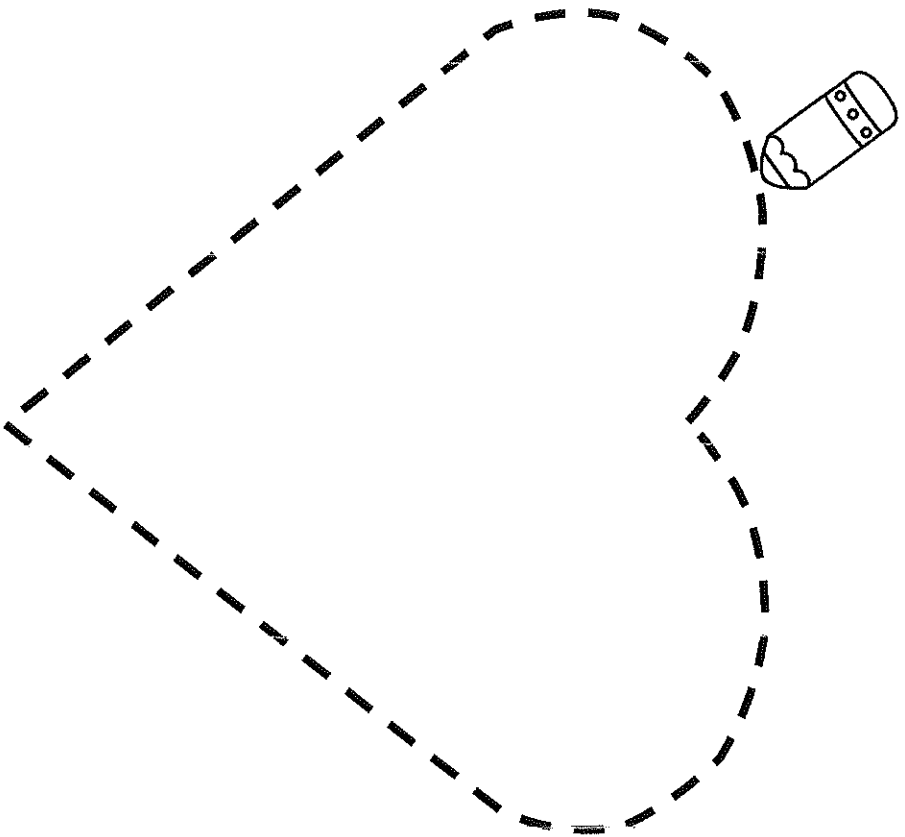

Trace. Color pink.

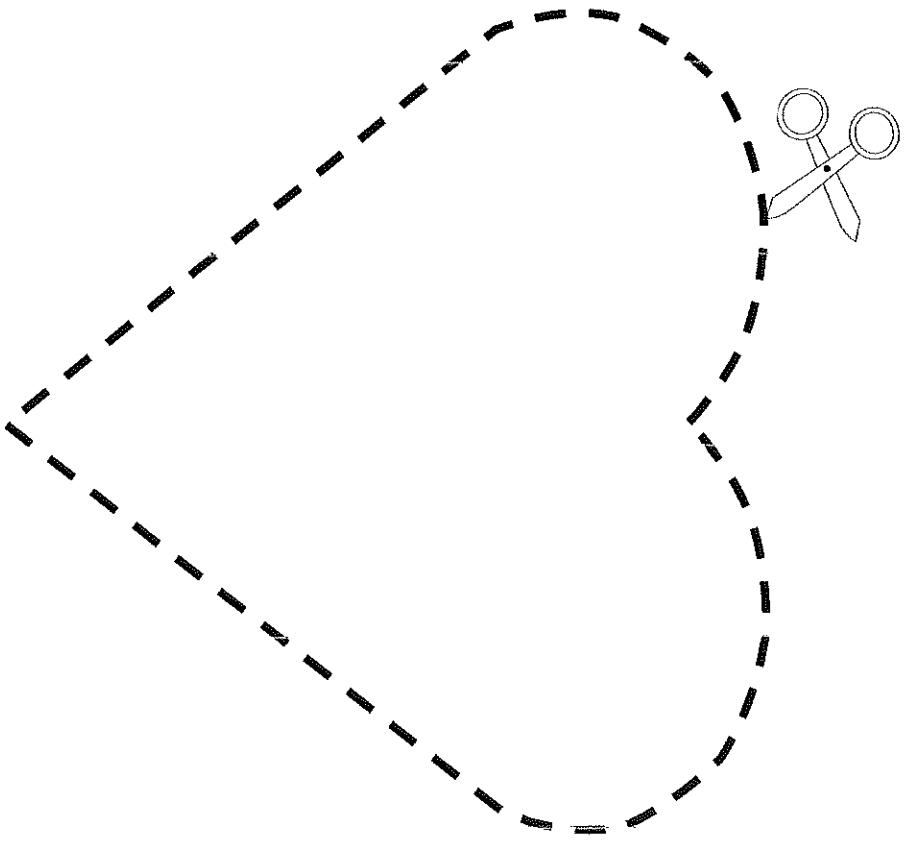
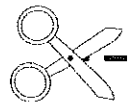

Cut. Color pink.

# DAY 7 of NTI Work

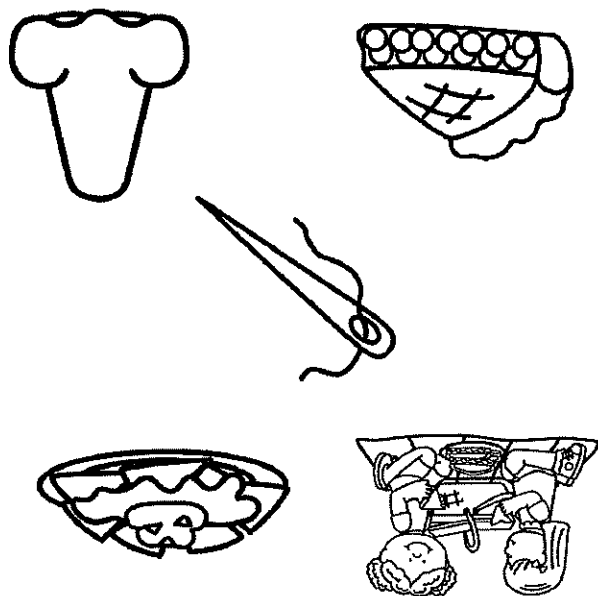

Color the items  
that start with N



Find and circle N

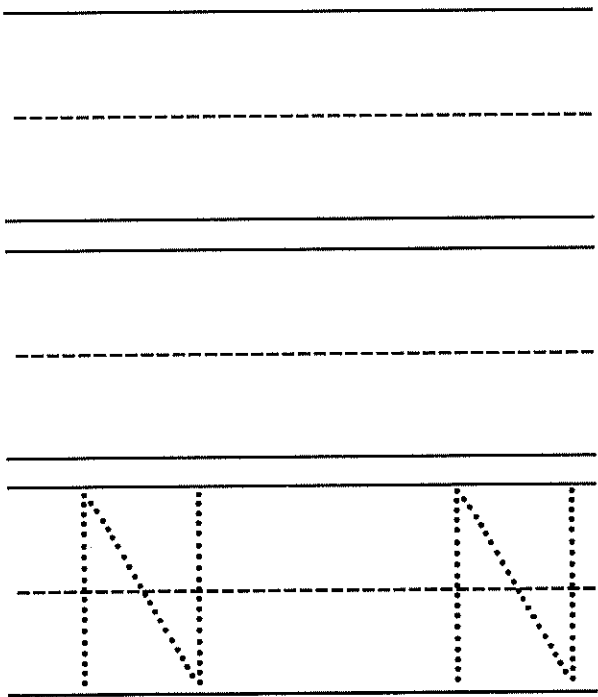

Trace and write

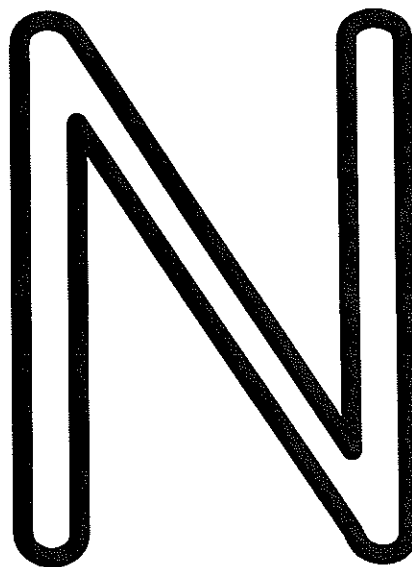

Color the letter

Name: \_\_\_\_\_

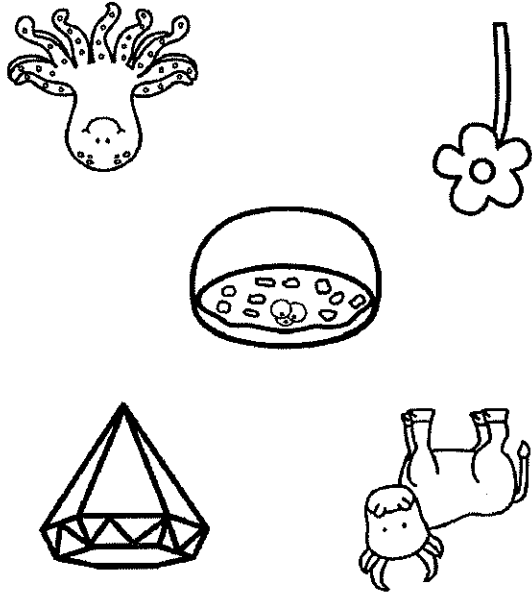

Color the items that start with O

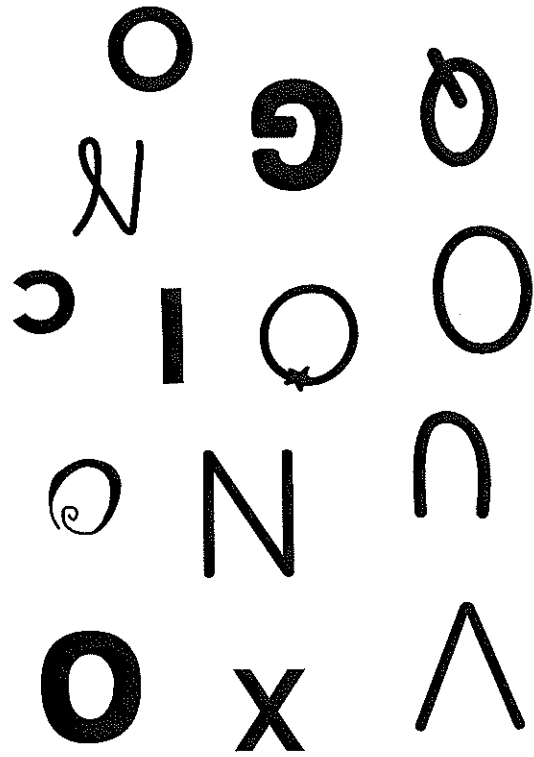

Find and circle O

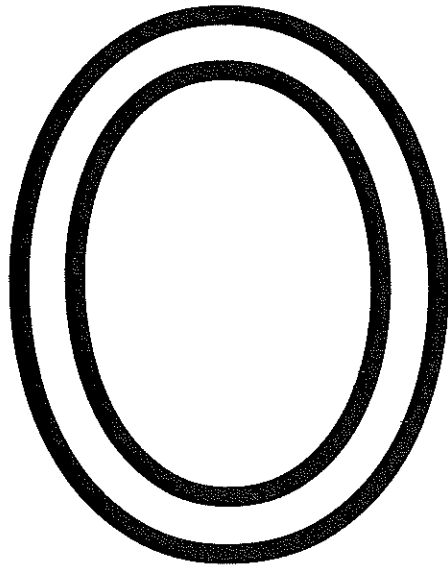

Color the letter

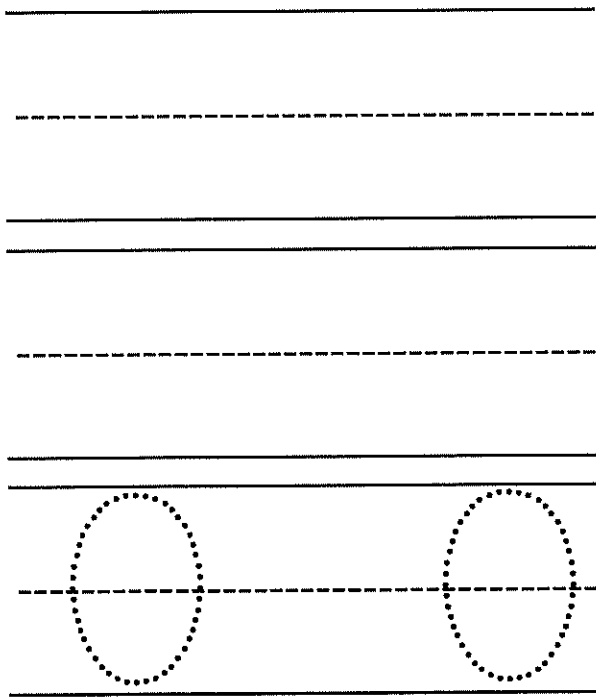

Trace and write

Name: \_\_\_\_\_

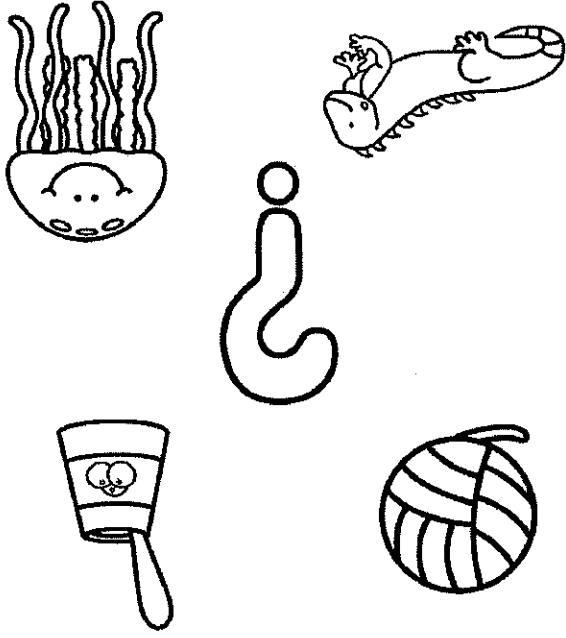

Color the items that start with Y

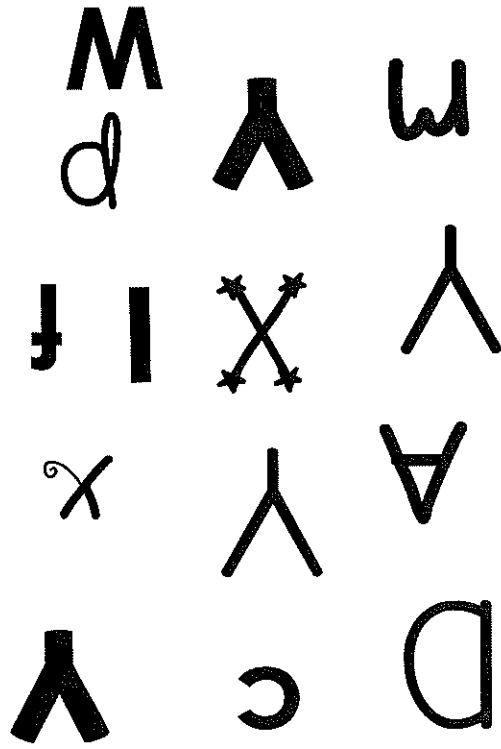

Find and circle Y

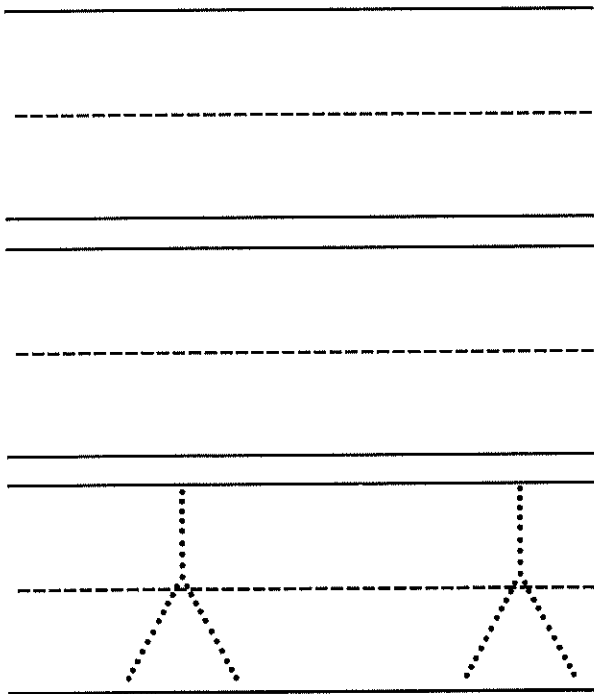

Trace and write

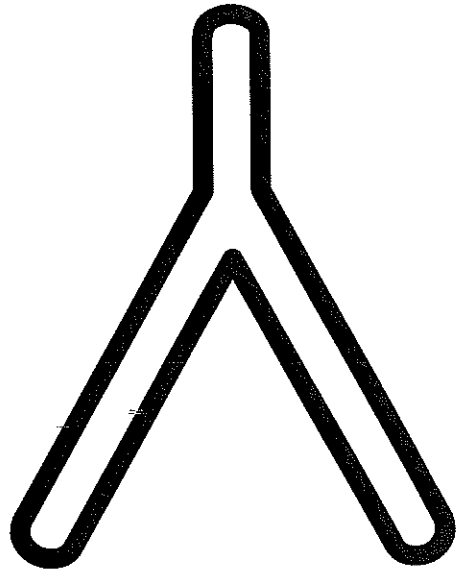

Color the letter

Name: \_\_\_\_\_

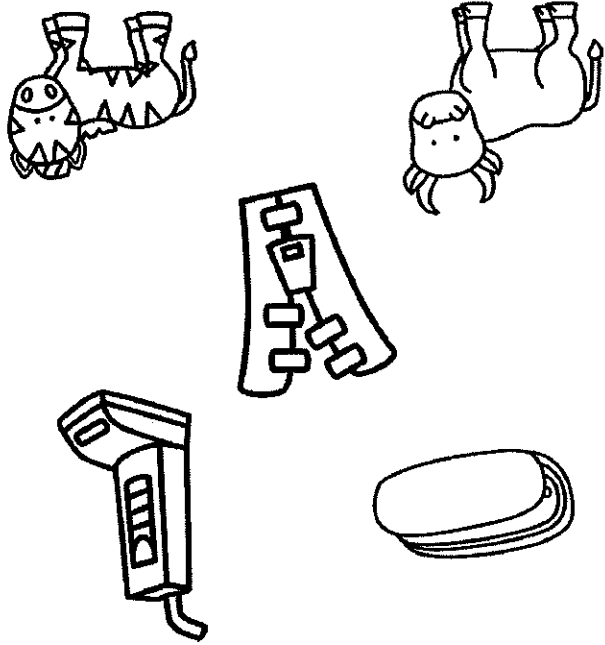

Color the items that start with Z

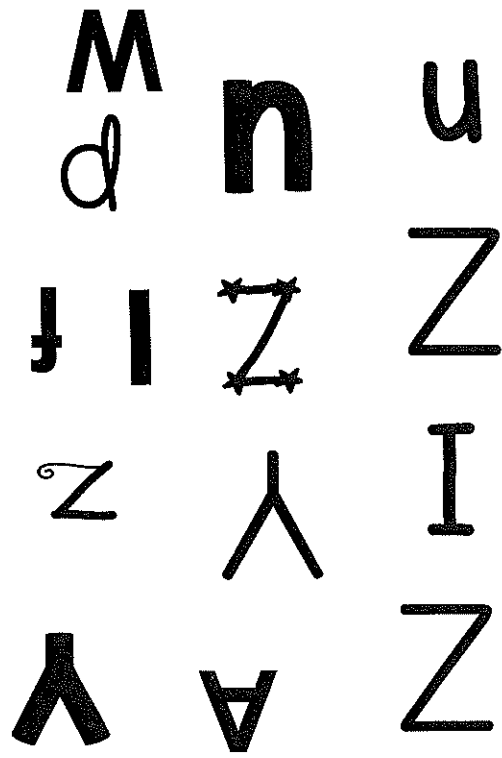

Find and circle Z

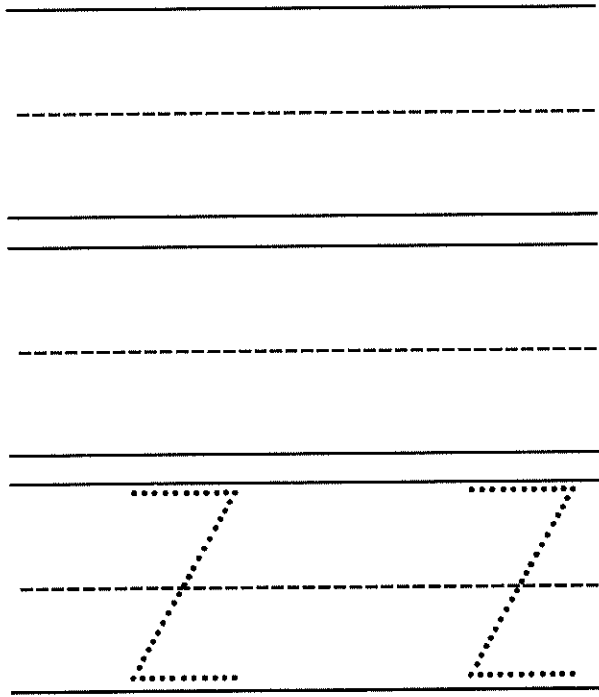

Trace and write

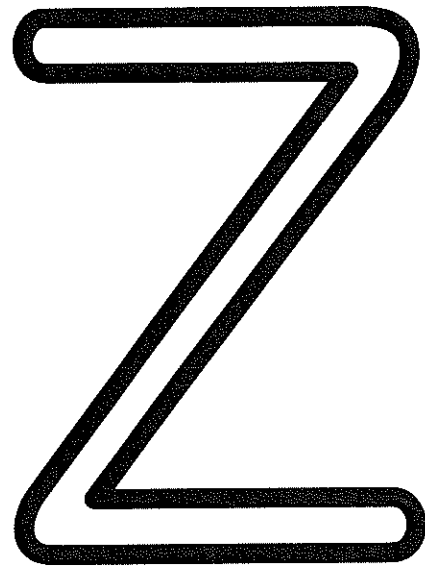

Color the letter

Name: \_\_\_\_\_

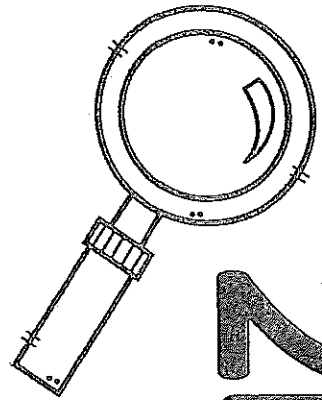

# 2D Shapes Hunt

Trace with a marker, pencil, pen, crayon, or paint with a Q-Tip.

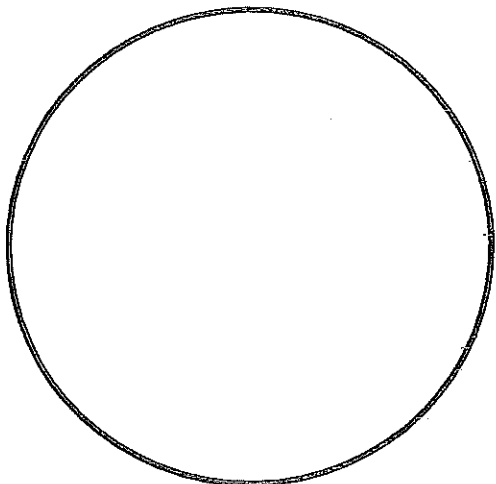
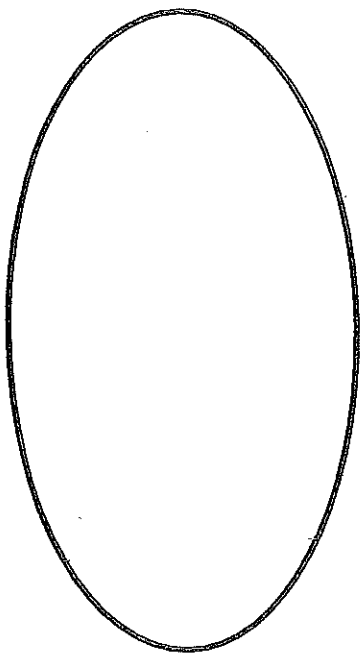
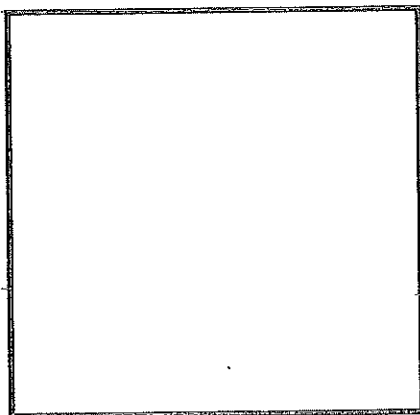
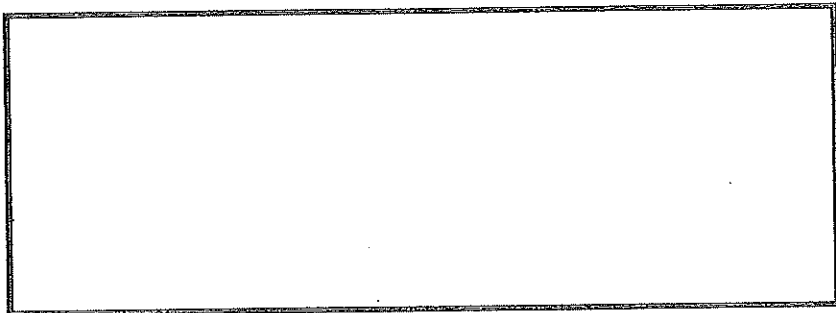
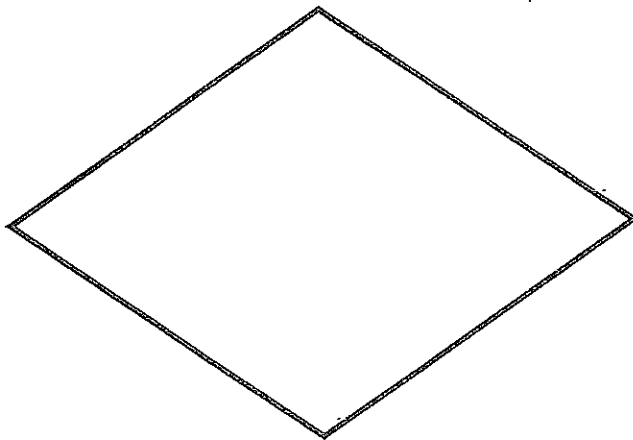
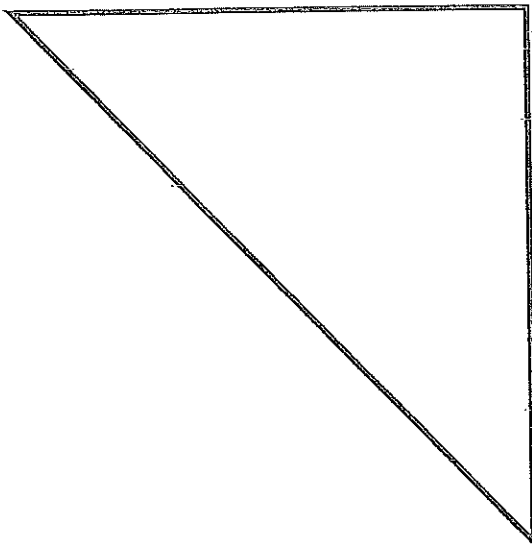
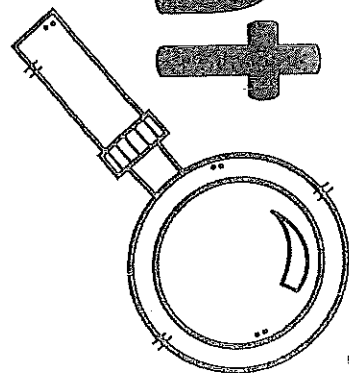

**DAY 8**  
**of NTI**  
**Work**



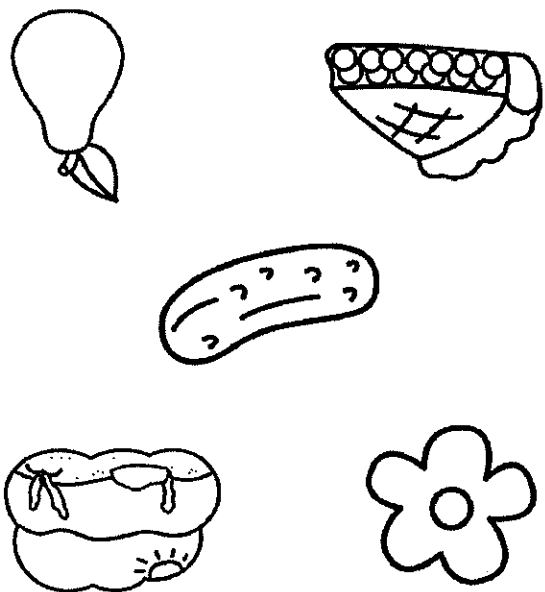

Color the items that start with p

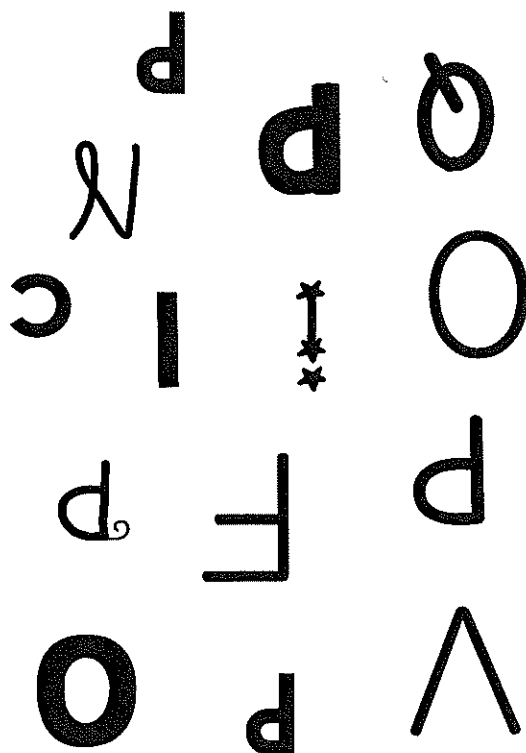

Find and circle p

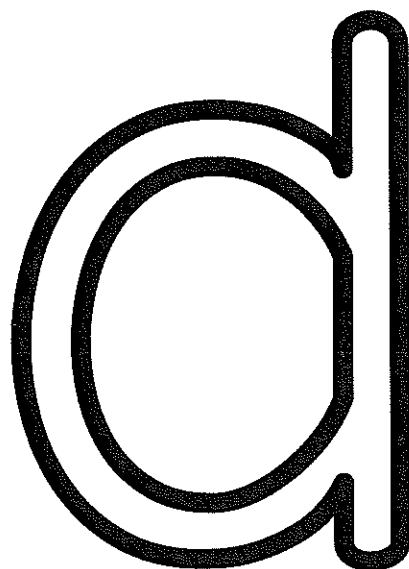

Color the letter

Handwriting practice lines consisting of four sets of solid top and bottom lines with a dashed middle line. The last set includes dotted lowercase 'p's for tracing.

Trace and write

Name: \_\_\_\_\_

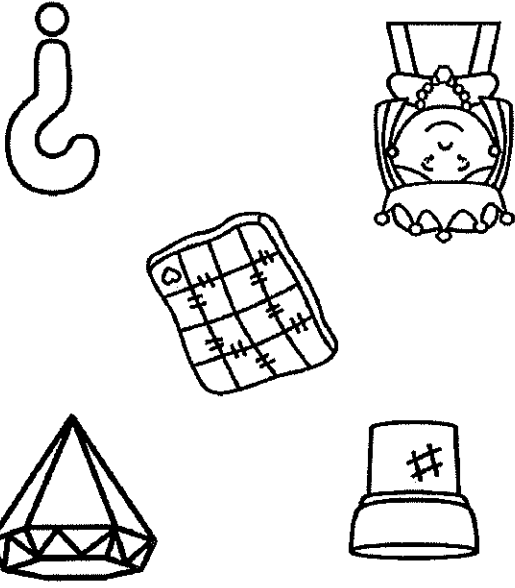

Color the items that start with Q

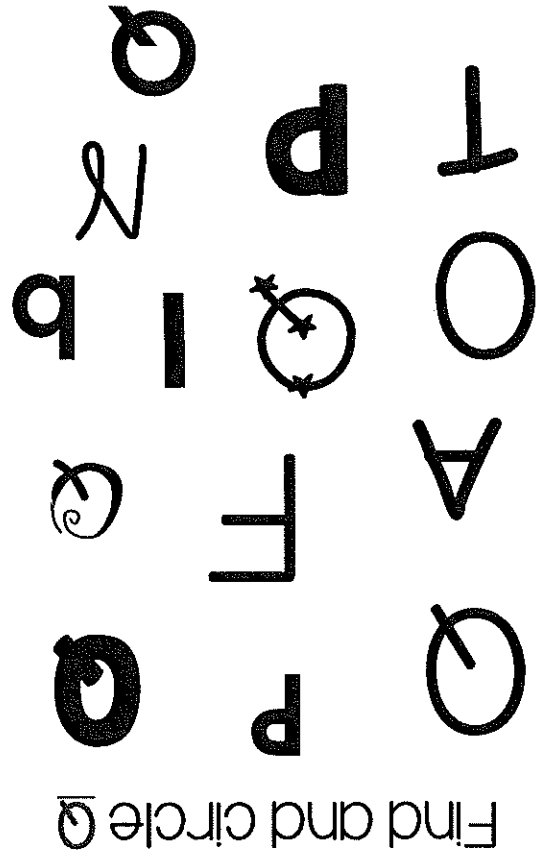

Find and circle Q

Handwriting practice lines with two dotted uppercase 'Q's for tracing.

Trace and write

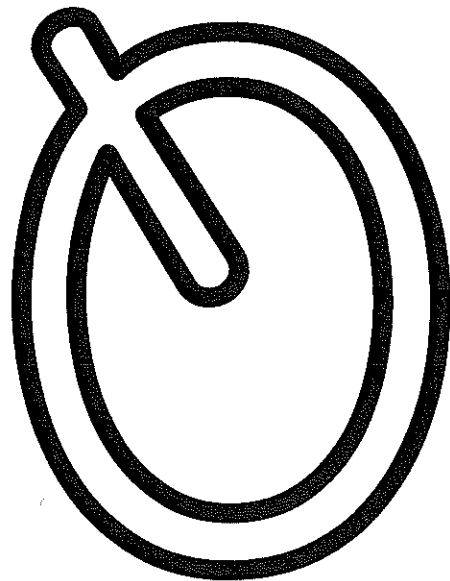

Color the letter

Name: \_\_\_\_\_



Color the items  
that start with R

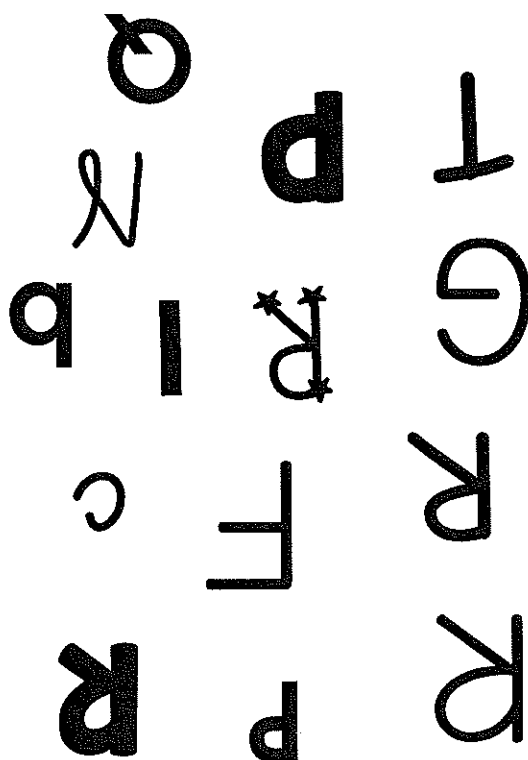
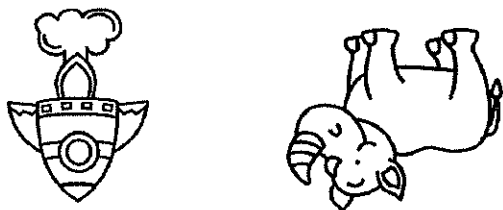

Find and circle R



Color the letter

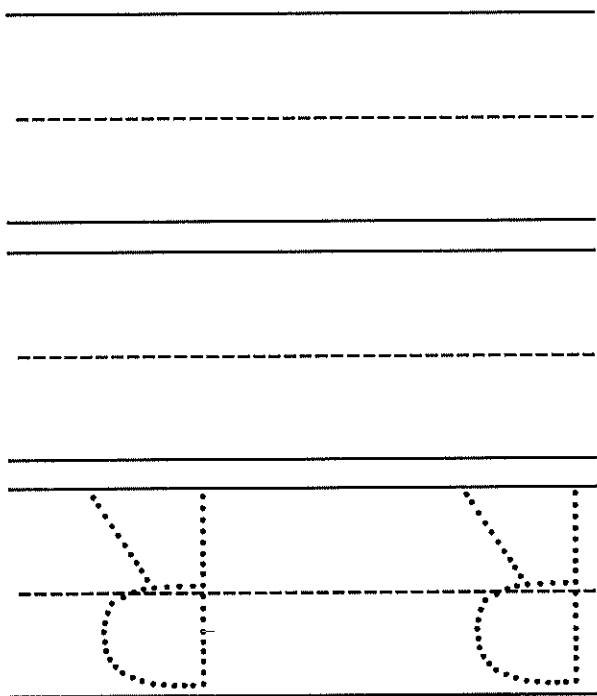

Trace and write

Name: \_\_\_\_\_

Draw a circle around each of the 2 things that are the same.

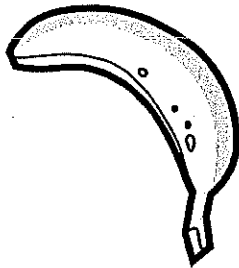
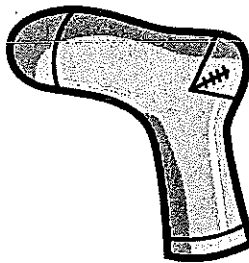
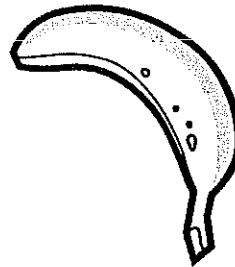
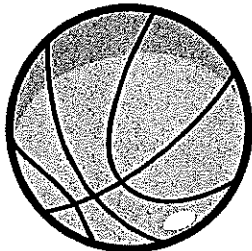
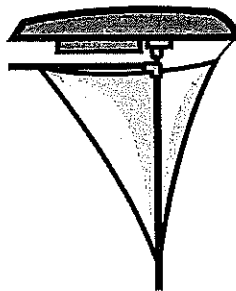
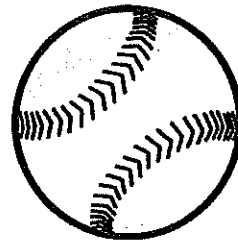
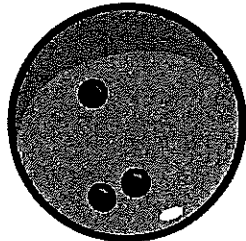
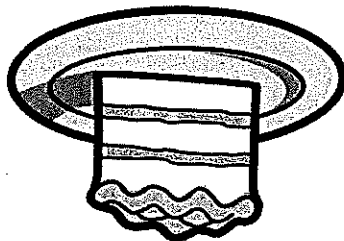
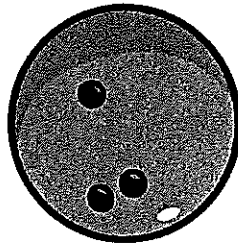
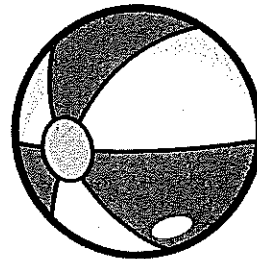
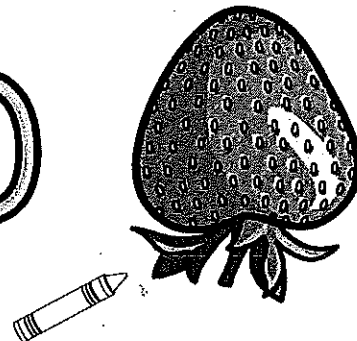
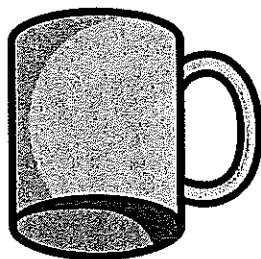
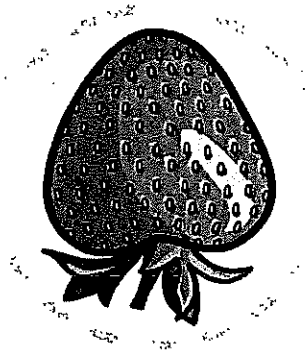
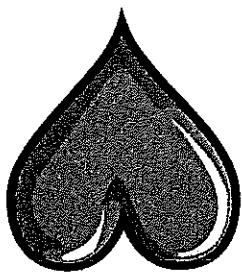

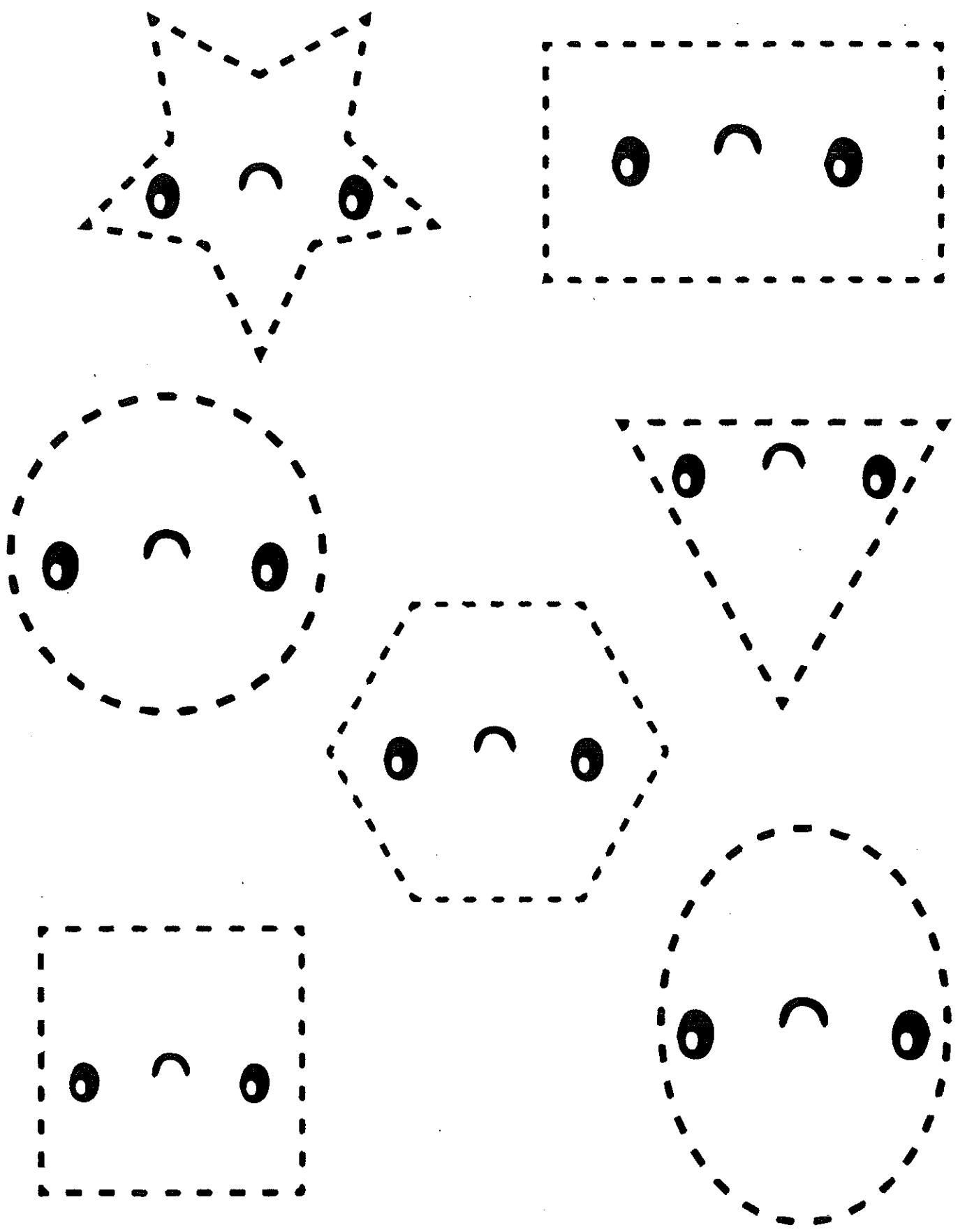

Trace the lines and color the shapes

**DAY 9**  
**of NTI**  
**Work**

T V L S

S S F P

S R I b S R

Find and circle S

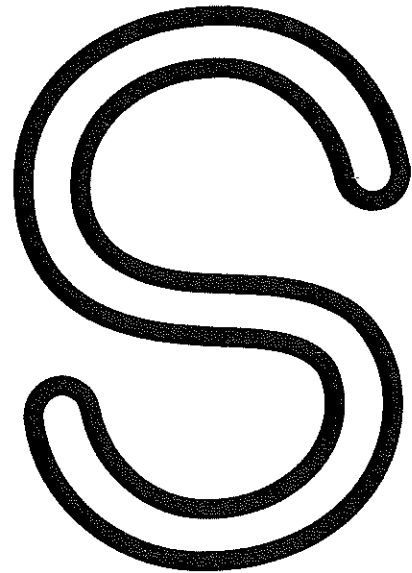

Color the letter

Color the items that start with S

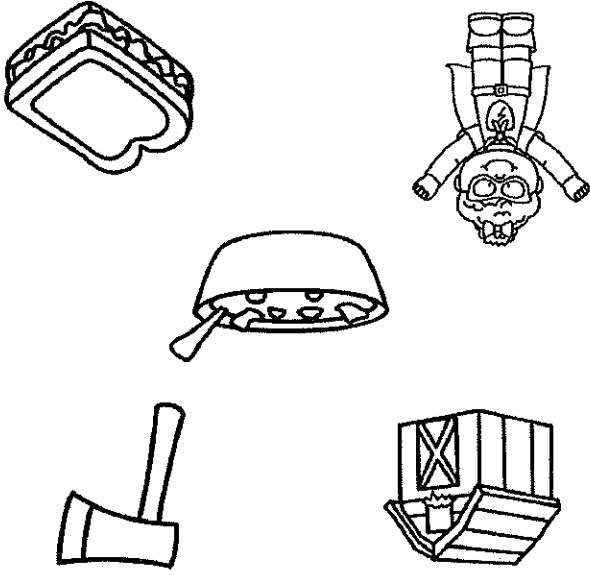

Trace and write

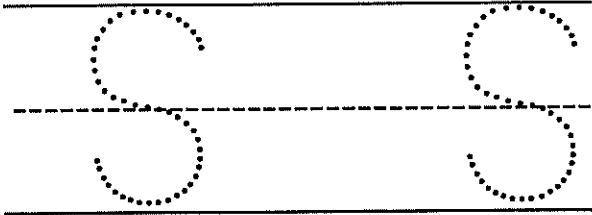

Blank handwriting lines for practicing writing the letter S.

Name: \_\_\_\_\_

T T L T

H P  
G I R  
S O S R

Find and circle I

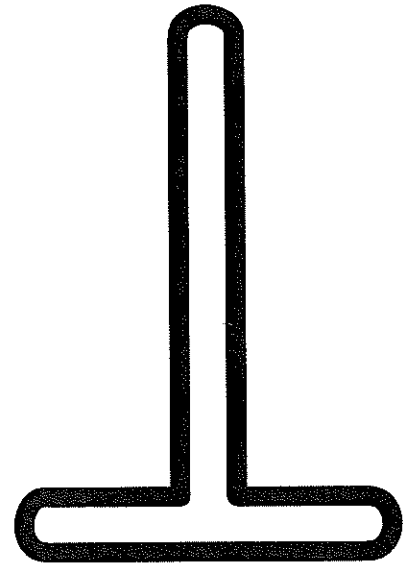

Color the letter

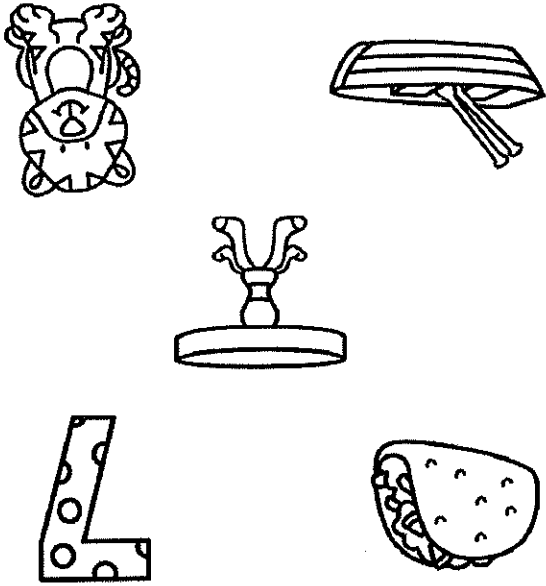

Color the items  
that start with I

Handwriting practice lines consisting of four sets of solid top and bottom lines with a dashed middle line. The last set includes a dotted uppercase letter 'T' for tracing.

Trace and write

Name: \_\_\_\_\_



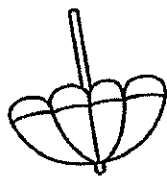
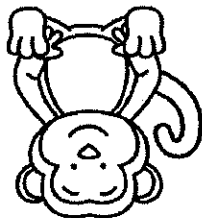
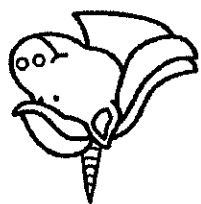

Color the items  
that start with u

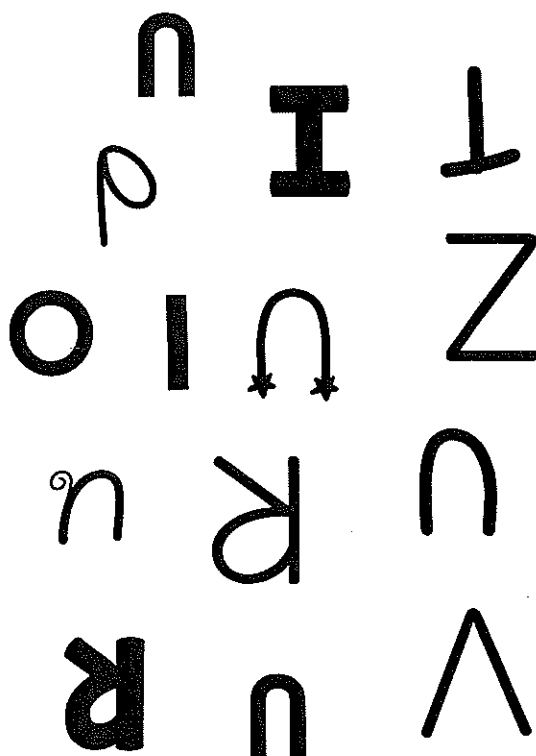

Find and circle u

Handwriting practice lines consisting of four sets of three horizontal lines (top, dashed middle, bottom). The first two sets are blank. The last two sets each contain a dotted lowercase letter 'u' for tracing.

Trace and write

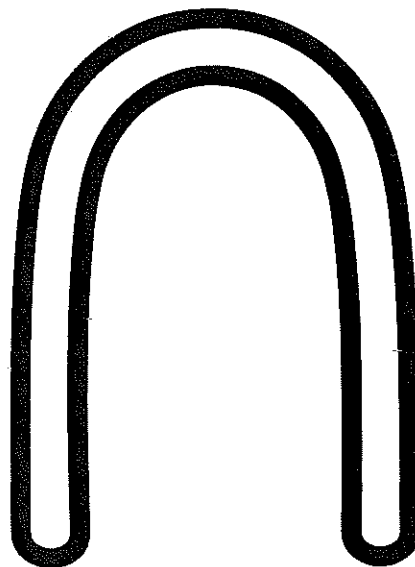

Color the letter

Name: \_\_\_\_\_

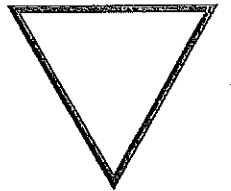
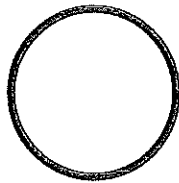
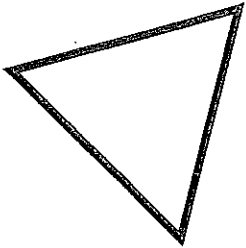
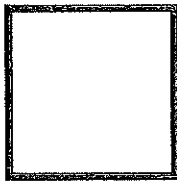
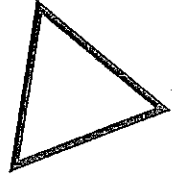
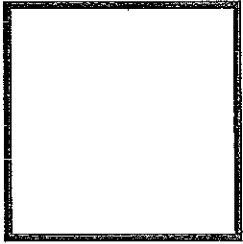
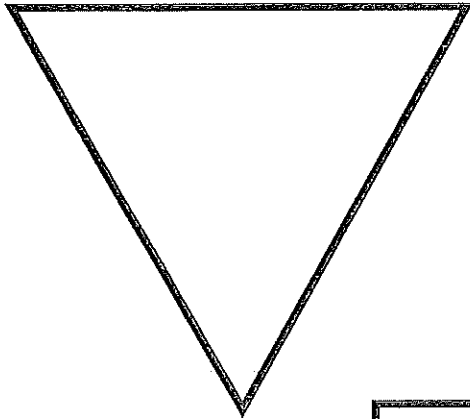
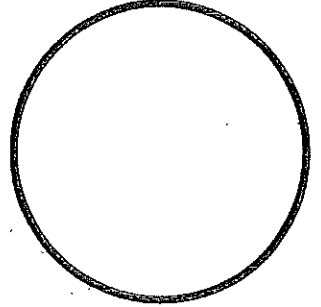
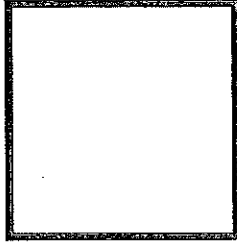
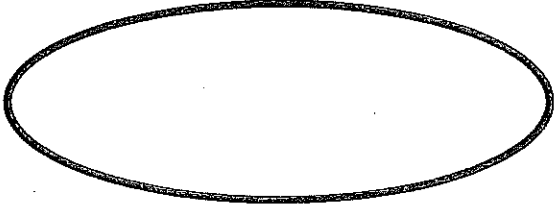
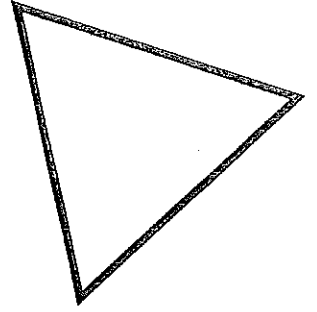
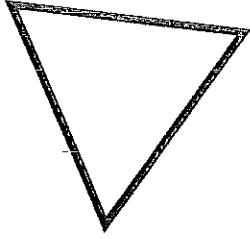
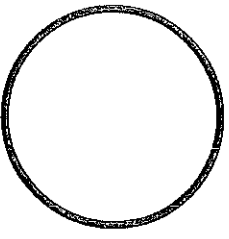

Find and color all the triangles.

# Triangles

Name: \_\_\_\_\_

# DAY 10 of NTI Work

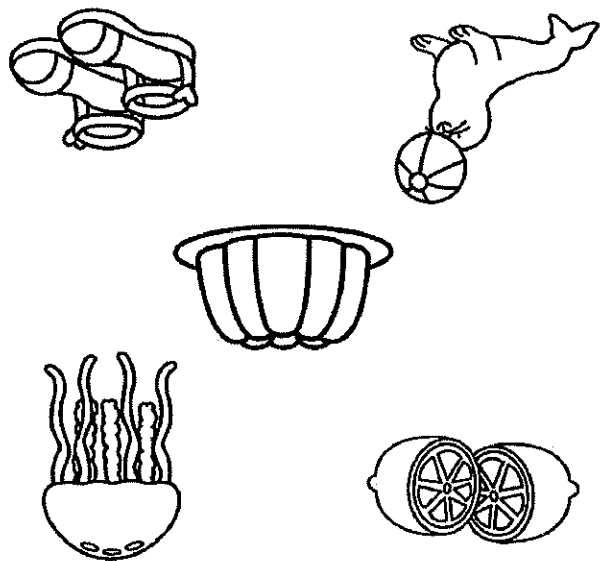

Color the items  
that start with J

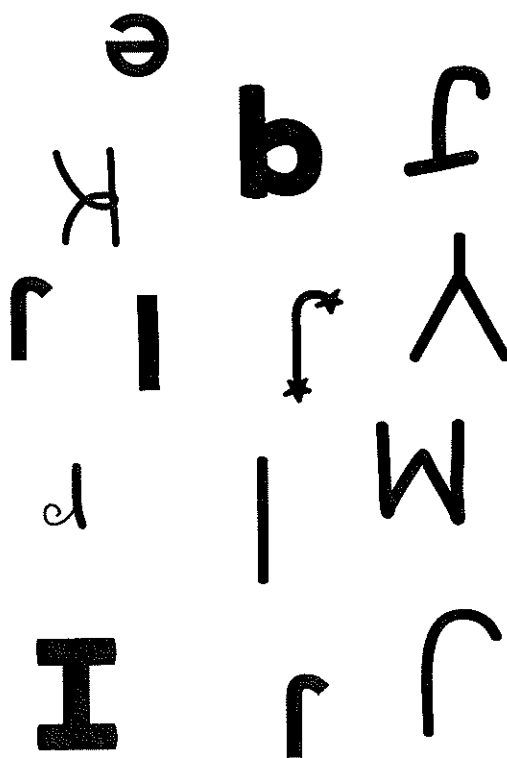

Find and circle J

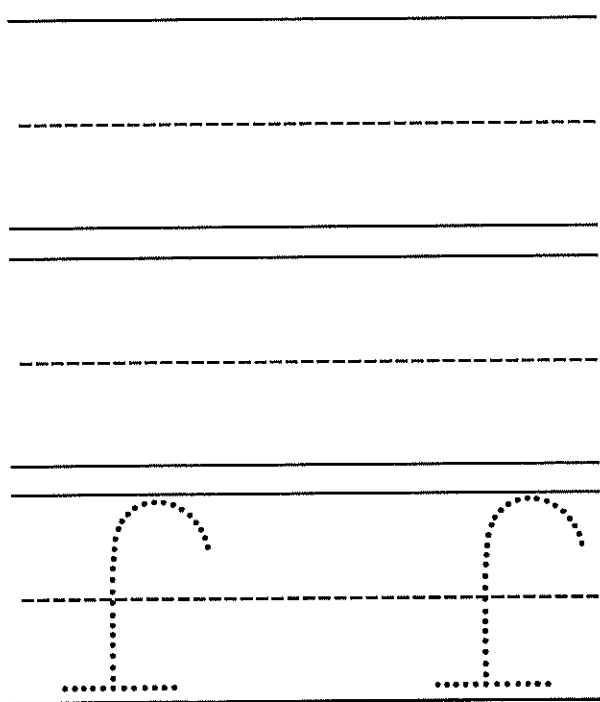

Trace and write

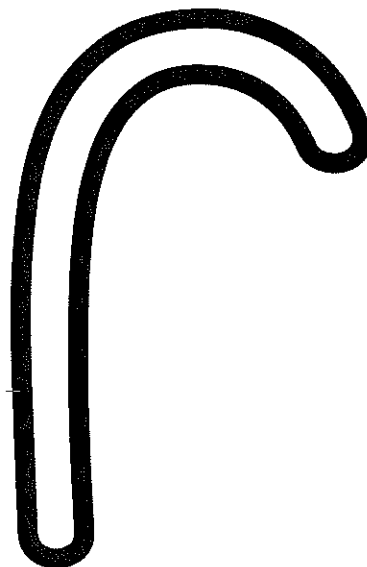

Color the letter

Name: \_\_\_\_\_

Name: \_\_\_\_\_

Color the letter

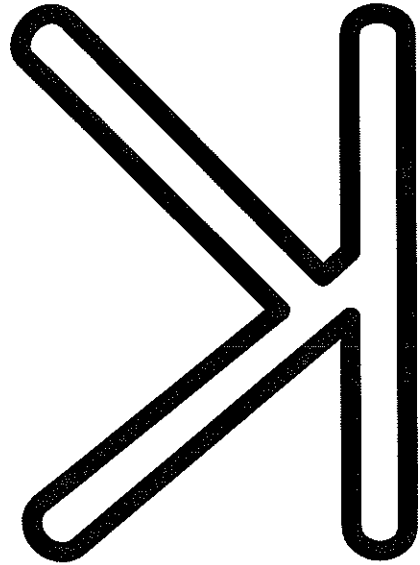

Find and circle K

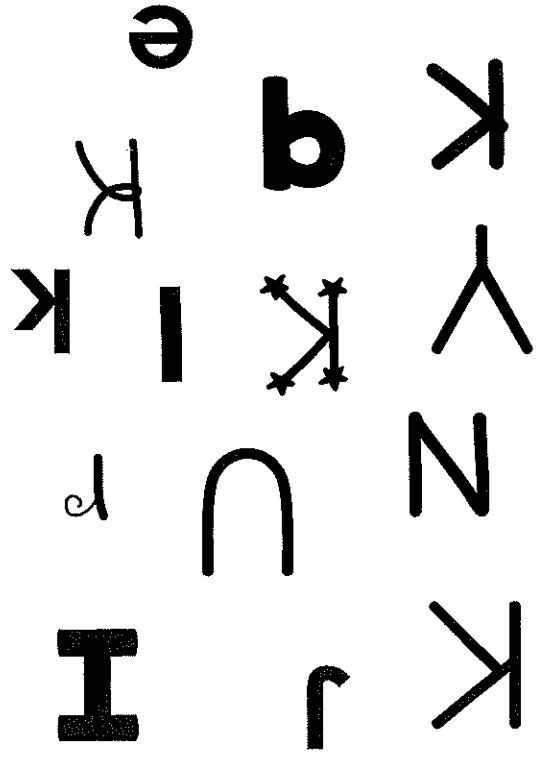

Trace and write

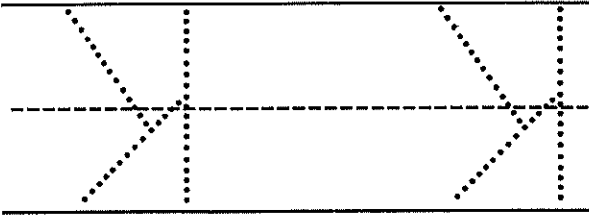

Handwriting practice lines consisting of three sets of solid top and bottom lines with a dashed middle line for tracing.

Color the items that start with K

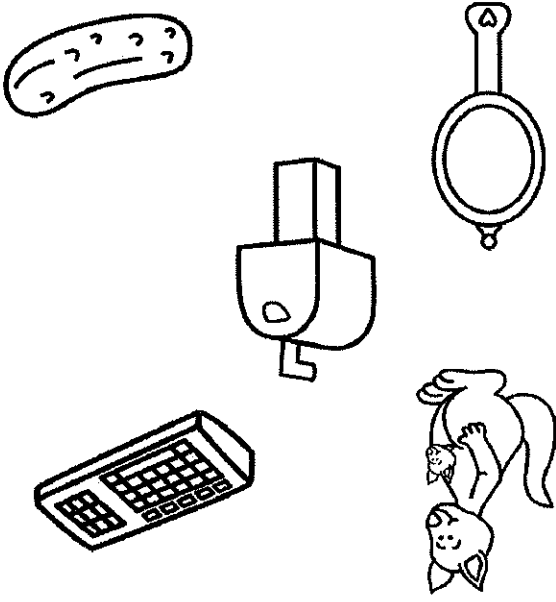

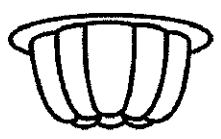
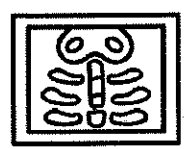
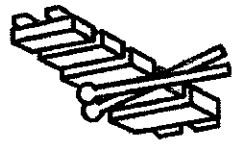
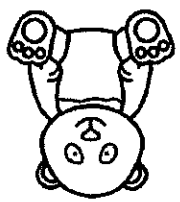
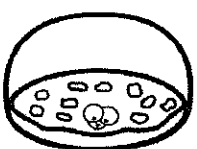

Color the items that start with X

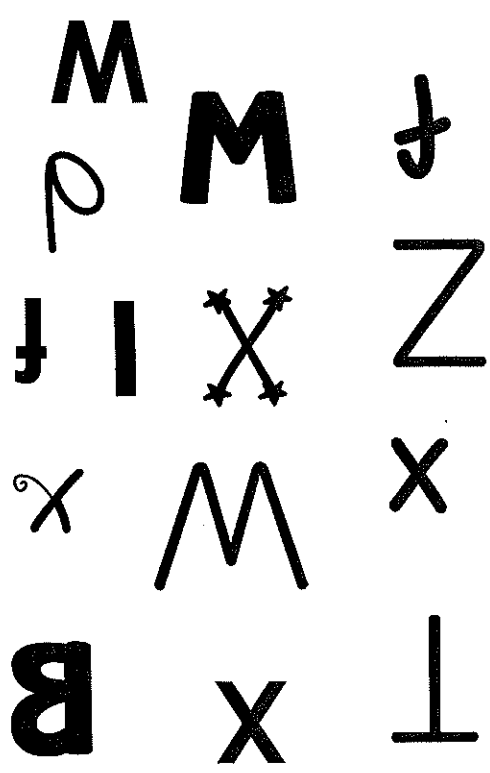

Find and circle X

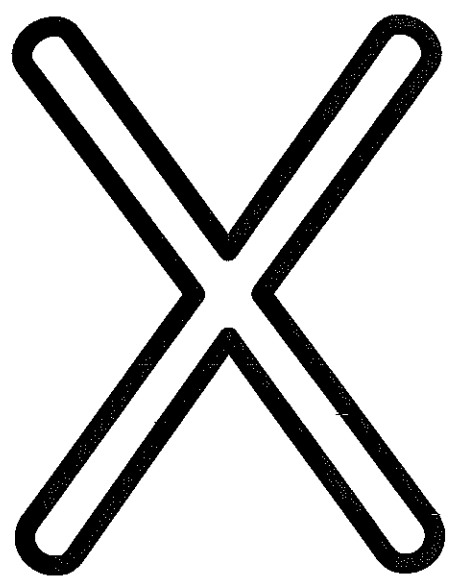

Color the letter

Handwriting practice lines with two dotted X's for tracing.

Trace and write

Name: \_\_\_\_\_

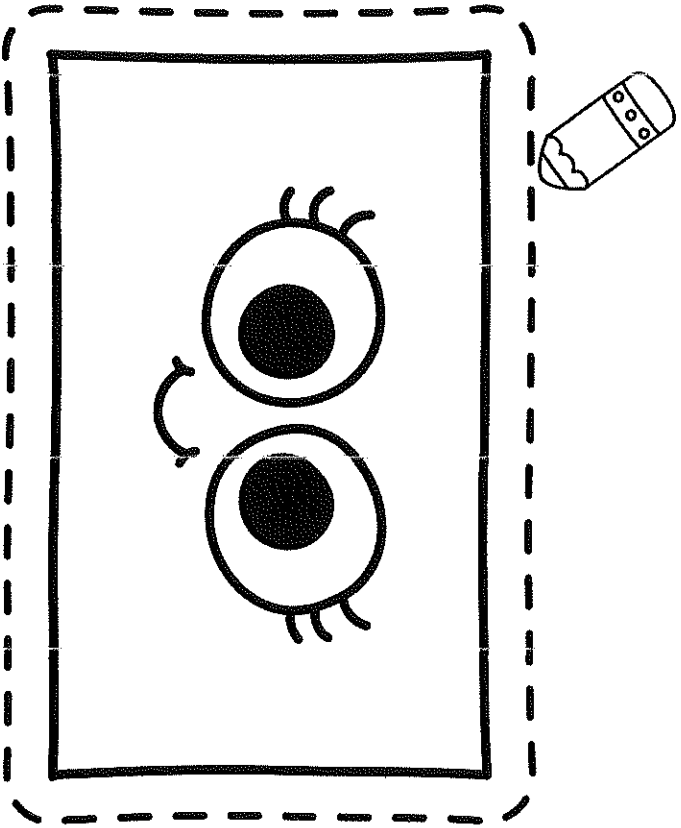

Trace. Color green.

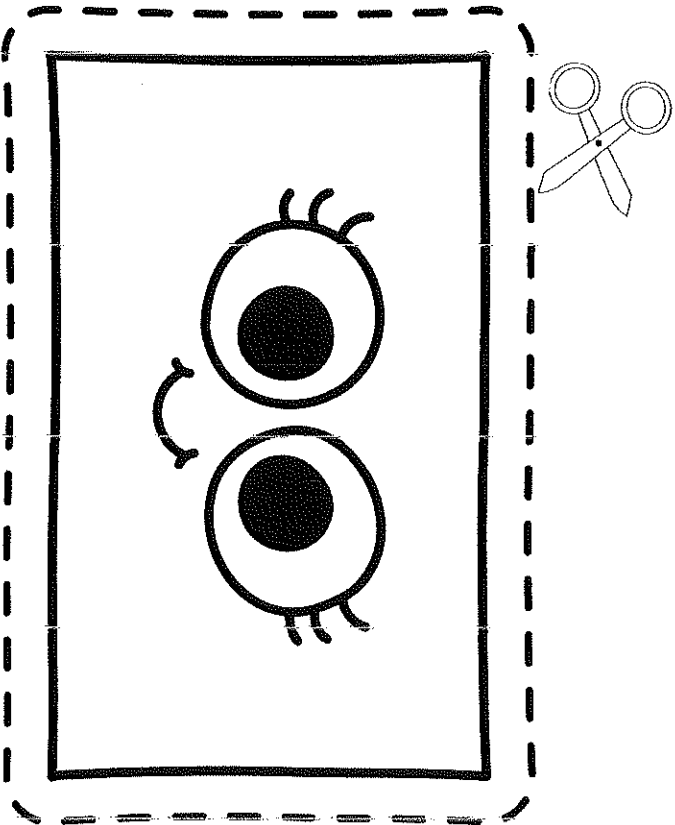

Cut. Color green.

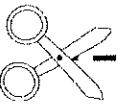

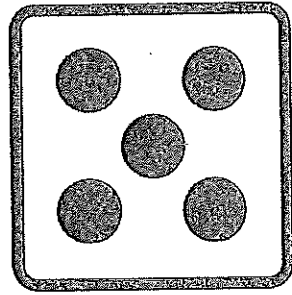
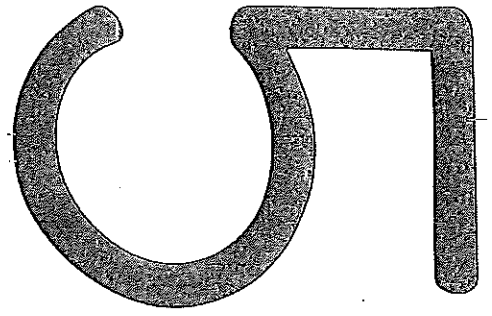

POCKET OF PRESCHOOL

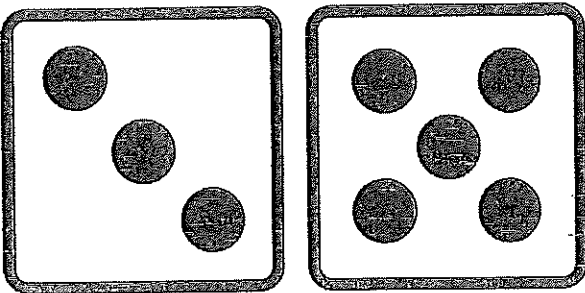
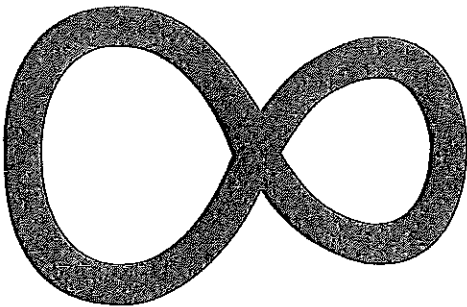
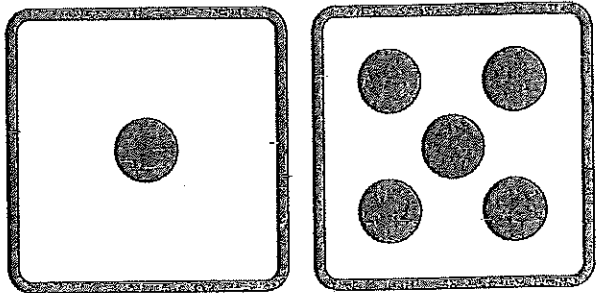
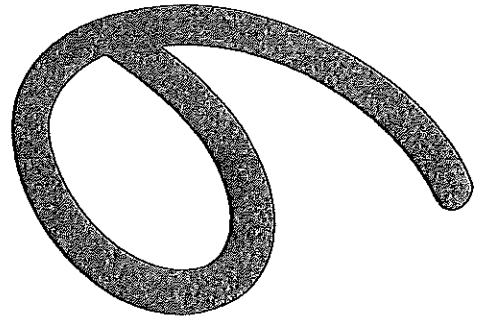
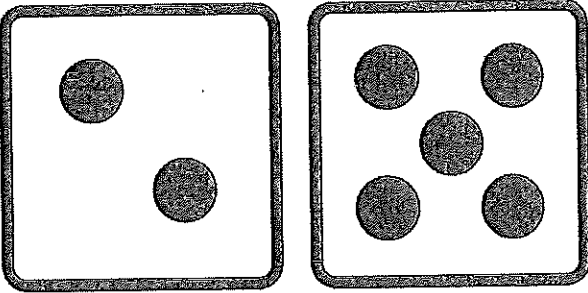
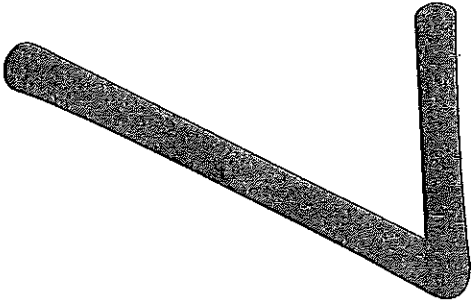

Cut out each puzzle. If doing all the number puzzles at once is overwhelming for your child, try just putting out 5-10 number puzzles at a time.